

ProVing

Display for fine dining



Bring your cellar to your customer. This graceful display is a magnet in fine restaurants and can accommodate any foods besides wine, thanks to a split refrigeration system that controls each display chamber. Not only a proven profit center, it is the ultimate shopping experience. LED lighting as standard.



Discover the Art of Display...

Proving I



Display for fine dining



Bring your cellar to your customer. This graceful display is a magnet in fine restaurants and can accommodate any foods besides wine, thanks to a split refrigeration system that controls each display chamber. Not only a proven profit center, it is the ultimate shopping experience. LED lighting as standard.



Discover the Art of Display...



Provino I cheese & charcuterie with custom finish

Visit our website for optional RAL colors and Materials finishes.

[RAL Colors Website](#)

[Materials Brochure PDF](#)

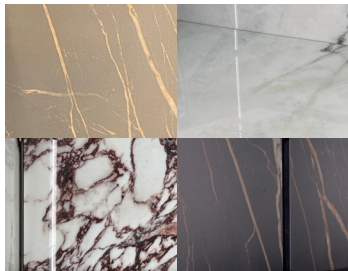

Examples of optional 6mm thick stone back panel behind shelf. For full selection see our Materials Brochure.

Project Name: _____

Item #: _____ Quantity: _____

PROVINO I

CHEESE & CHARCUTERIE

MODELS: PROVINO I CC700, CC1400, CC1400-2T, CC2100, CC2800

STANDARD FEATURES

- Solid Side
- Dual Medium Temperature Version with intermediate double glass divider
- Triple pane glass premium door
- Steel load bearing structure
- 3000°K LED lighting with dimmer switch
- Touch Control
- Ventilated cooling
- interior vertical shelf support in stainless steel
- adjustable feet
- standard steel 304A
- stainless steel interior and exterior
- Stainless steel shelves adjustable in height on racks
- programmed automatic electric defrost
- Approvals: cETLus, ETL sanitation, certified CE
- Self-contained
- Condensate evaporator pan

OPTIONS

- RAL Color Option powder coated door handles exterior and interior over stainless steel
- 6mm thick stone back panel behind shelf
- Front wood laminate door and handles
- interior shelf trim
- 6mm thick stone back panel behind shelf
- Glass Sides
- Sliding Doors
- Front wood laminate storage doors finish on base
- top door and interior shelf trim
- Top door
- door locks
- Remote application
- Top mounted condensing unit
- water cooled
- central refrigeration rack
- 60 Hz components UL
- Narrow depth
- front breathing available for 1400 - 2800 models



*Oscartek® reserves the right to change, modify, discontinue, or change any features, sizes, or capacity on any model without prior notice.

Discover the Art of Display...

MODELS: PROVINO I CC700, CC1400, CC1400-2T, CC2100, CC2800

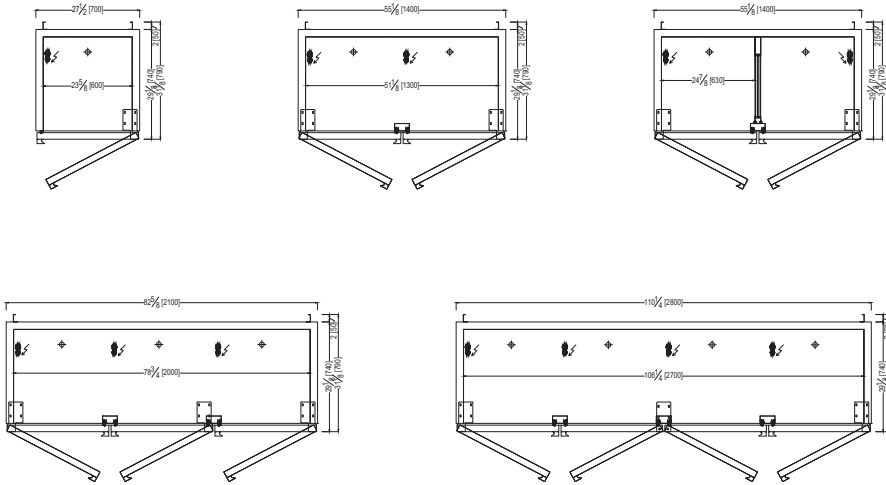
**PROVINO I
PLAN VIEWS**



ELECTRICAL LEGEND	
	REFRIGERATION LINES
	DRAIN
	POWER

**PROVINO I
REAR ELEVATIONS (OPERATOR SIDE)**



*Oscartek® reserves the right to change, modify, discontinue, or change any features, sizes, or capacity on any model without prior notice.

OSCARTEK®
512 South Airport Blvd., South San Francisco, CA 94080
Tel: 855.885.2400 | 650.342.2400 | Fax: 650.342.7400
sales@oscartek.com | www.oscartek.com



MODELS: PROVINO I CC700, CC1400, CC1400-2T, CC2100, CC2800

PROVINO I - STANDARD DEPTH SECTION VIEWS

**STANDARD:
SELF-CONTAINED**

**OPTIONAL:
GLASS SIDE**

**STANDARD:
REMOTE**

**OPTIONAL:
TOP MOUNTED
CONDENSING UNIT**

**OPTIONAL:
SLIDING DOORS
ONLY IN SOLID SIDES AND
2100, 2800 MODELS**

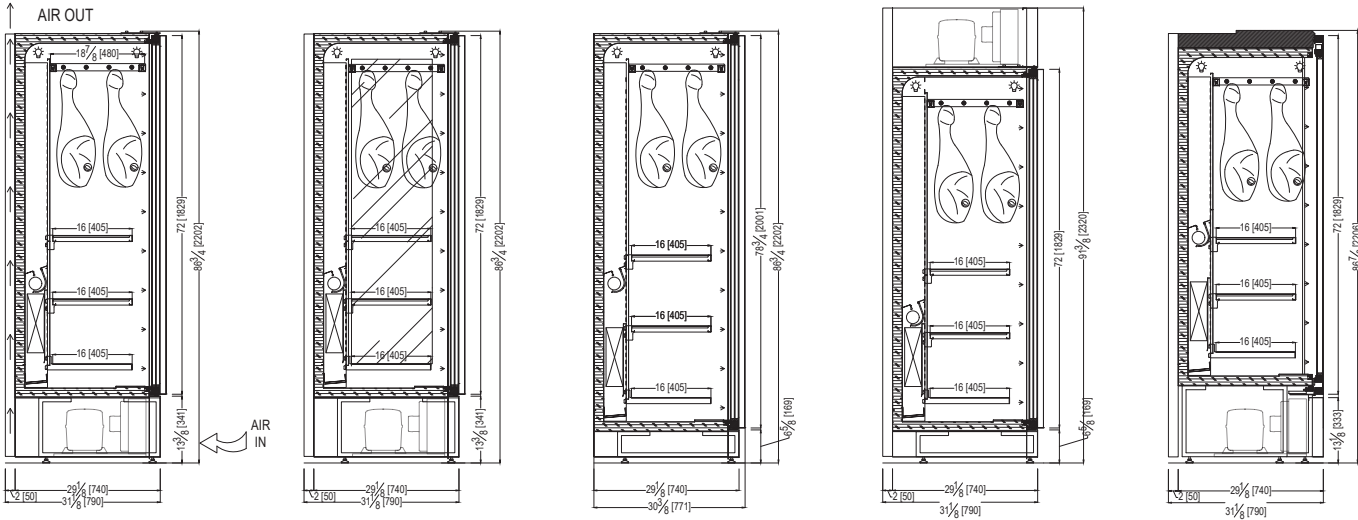

PROVINO I - NARROW DEPTH SECTION VIEWS

**STANDARD:
SELF-CONTAINED**

**OPTIONAL:
GLASS SIDE**

**STANDARD:
REMOTE**

**OPTIONAL:
TOP MOUNTED
CONDENSING UNIT**

**OPTIONAL:
SLIDING DOORS
ONLY IN SOLID SIDES AND
2100, 2800 MODELS**

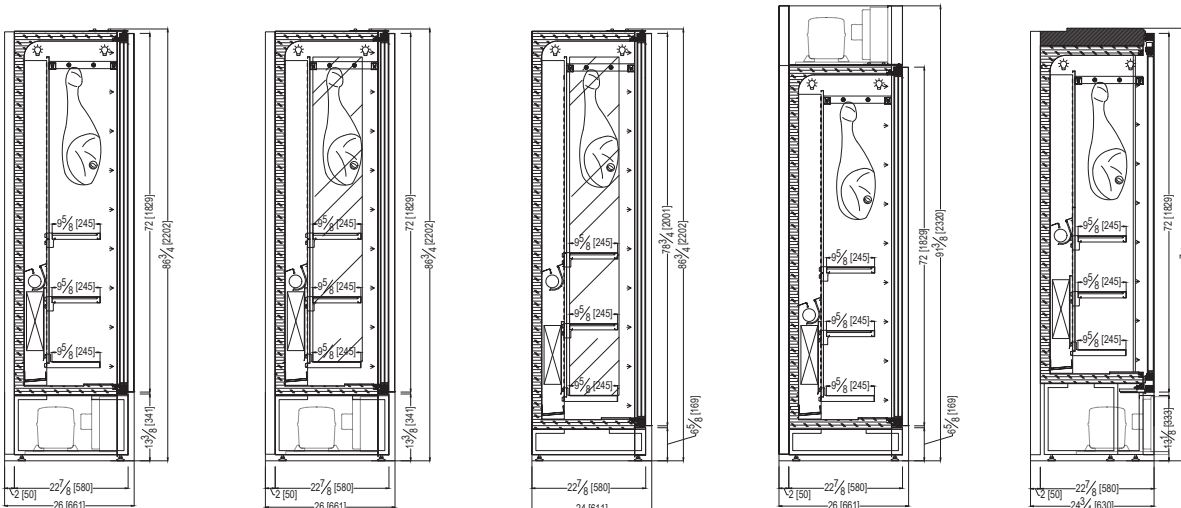

*Oscartek® reserves the right to change, modify, discontinue, or change any features, sizes, or capacity on any model without prior notice.

OSCARTEK®
512 South Airport Blvd., South San Francisco, CA 94080
Tel: 855.885.2400 | 650.342.2400 | Fax: 650.342.7400
sales@oscartek.com | www.oscartek.com





Discover the Art of Display...

Project Name: _____

Item #: _____ Quantity: _____

MODELS: PROVINO I CC700, CC1400, CC1400-2T, CC2100, CC2800

PROVINO I CHEESE & CHARCUTERIE - SELF CONTAINED						
TECHNICAL FEATURES		MODELS				
Model Name (Model ETL Code)		PROVINO I CC700 (MUROGALA1P)	PROVINO I CC1400 (MUROGALA2P)	PROVINO I CC1400-2T (MUROGALA1P)X2	PROVINO I CC2100 (MUROGALA3P)	PROVINO I CC2800 (MUROGALA4P)
External Dimensions (L-D-H)	Inches	*27 1/2" - 32 3/8" - 86 3/4"	*55 1/8" - 32 3/8" - 86 3/4"	*55 1/8" - 32 3/8" - 86 3/4"	*82 5/8" - 32 3/8" - 86 3/4"	*110 1/4" - 32 3/8" - 86 3/4"
	Inches-MM	*700 - 821 - 2022	*1400 - 821 - 2022	*1400 - 821 - 2022	*2100 - 821 - 2022	*2800 - 821 - 2022
Crated Dimensions (L-D-H)	Inches	35" - 39" - 98"	63" - 39" - 98"	63" - 39" - 98"	90" - 39" - 98"	118" - 39" - 98"
	Inches-MM	880 - 970 - 2470	1580 - 970 - 2470	1580 - 970 - 2470	2280 - 970 - 2470	2980 - 970 - 2470
Refrigeration	Type	Fan - Ventilated	Fan - Ventilated	Fan - Ventilated	Fan - Ventilated	Fan - Ventilated
Refrigeration Display Area	Type	Deck	Deck	Deck	Deck	Deck
Number of Glass Doors	#	1	2	2	3	4
Operating Temperature	°F	32°F to 41°F	32°F to 41°F	32°F to 41°F	32°F to 41°F	32°F to 41°F
Condensing Units	#	1	2	2	3	4
Compressor	Nr./Type	1 / Hermetic	1 / Hermetic	1 / Hermetic	1 / Hermetic	2 / Hermetic
Electric Supply	(V/Ph/Hz)	220/1/60	220/1/60	(2) 220/1/60	220/1/60	220/1/60
Power Consumption	(W/A)	700/3.9	1200/6.9	(2) 650/3.5	1700/9.5	2300/12.9
Defrost	Mode/Type	Automatic	Automatic	Automatic	Automatic	Automatic
Climatic Class	°F/%RH	75°F-55%RH	75°F-55%RH	75°F-55%RH	75°F-55%RH	75°F-55%RH
Refrigerant Gas	Type	R290	R290	R290	R290	R291
Net Weights	Lb	309	573	661	750	904
Crated Weights	Lb	369	633	721	810	964

*DIMENSIONS WITH POLISHED S/S SIDES

PROVINO I CHEESE & CHARCUTERIE - REMOTE						
TECHNICAL FEATURES		MODELS				
Model Name (Model Code)		PROVINO I CC700 (MUROGALA1P)	PROVINO I CC1400 (MUROGALA2P)	PROVINO I CC1400-2T (MUROGALA1P)X2	PROVINO I CC2100 (MUROGALA3P)	PROVINO I CC2800 (MUROGALA4P)
External Dimensions (L-D-H)	Inches	*27 1/2" - 30 3/8" - 86 3/4"	*55 1/8" - 30 3/8" - 86 3/4"	*55 1/8" - 30 3/8" - 86 3/4"	*82 5/8" - 30 3/8" - 86 3/4"	*110 1/4" - 30 3/8" - 86 3/4"
	Inches-MM	*700 - 771 - 2022	*1400 - 771 - 2022	*1400 - 771 - 2022	*2100 - 771 - 2022	*2800 - 771 - 2022
Crated Dimensions (L-D-H)	Inches	35" - 39" - 98"	63" - 39" - 98"	63" - 39" - 98"	90" - 39" - 98"	118" - 39" - 98"
	Inches-MM	880 - 970 - 2470	1580 - 970 - 2470	1580 - 970 - 2470	2280 - 970 - 2470	2980 - 970 - 2470
Refrigeration	Type	Fan - Ventilated	Fan - Ventilated	Fan - Ventilated	Fan - Ventilated	Fan - Ventilated
Refrigeration Display Area	Type	Deck	Deck	Deck	Deck	Deck
Number of Glass Doors	#	1	2	2	3	4
Operating Temperature	°F	32°F to 41°F	32°F to 41°F	32°F to 41°F	32°F to 41°F	32°F to 41°F
Condensing Units	#	1	2	2	3	4
Compressor	Nr./Type	1 / Hermetic	1 / Hermetic	1 / Hermetic	1 / Hermetic	2 / Hermetic
BTU'S @ +14°F Evap Temperature	BTU/H	2730	4980	(2) 2500	6830	7950
Electric Supply	(V/Ph/Hz)	220/1/60	220/1/60	(2) 220/1/60	220/1/60	220/1/60
Power Consumption	(W/A)	700/3.9	1200/6.9	(2) 650/3.5	1700/9.5	2300/12.9
Defrost	Mode/Type	Automatic	Automatic	Automatic	Automatic	Automatic
Climatic Class	°F/%RH	75°F-55%RH	75°F-55%RH	75°F-55%RH	75°F-55%RH	75°F-55%RH
Refrigerant Gas	Type	R452a	R452a	R452a	R452a	R452a
Pipe Size (Suction-Liquid)	(INCHES)	15/32"- 15/64"	35/64" - 5/16"	(2) 15/32"- 15/64"	5/8" - 5/16"	45/64" - 25/64"
Net Weights	Lb	309	573	661	750	904
Crated Weights	Lb	369	633	721	810	964

*DIMENSIONS WITH POLISHED S/S SIDES

*Oscartek® reserves the right to change, modify, discontinue, or change any features, sizes, or capacity on any model without prior notice.

OSCARTEK®
512 South Airport Blvd., South San Francisco, CA 94080
Tel: 855.885.2400 | 650.342.2400 | Fax: 650.342.7400
sales@oscartek.com | www.oscartek.com





Discover the Art of Display...



Provino I Dry Aged Meat with shelves and custom finish.

Visit our website for optional RAL colors and Materials finishes.

[RAL Colors Website](#)

[Materials Brochure PDF](#)

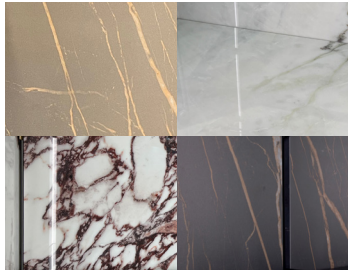

Examples of optional 6mm thick stone back panel behind shelf. For full selection see our Materials Brochure.

Project Name: _____

Item #: _____ Quantity: _____

PROVINO I DRY AGED MEAT

MODELS: PROVINO I DAM700, DAM1400, DAM2100, DAM2800

STANDARD FEATURES

- Solid Side
- Dual Medium Temperature Version with intermediate double glass divider
- Triple pane glass premium door
- Steel load bearing structure
- 3000°K LED lighting with dimmer switch
- Touch Control
- Ventilated cooling
- interior vertical shelf support in stainless steel
- adjustable feet
- standard steel 304A
- stainless steel interior and exterior
- Stainless steel shelves adjustable in height on racks
- programmed automatic electric defrost
- Approvals: cETLus, ETL sanitation, certified CE
- Self-contained
- Condensate evaporator pan
- Reverse Osmosis System for humidity control
- WATER INLET / DISCHARGE REQUIRED

OPTIONS

- RAL Color Option powder coated door handles exterior and interior over stainless steel
- 6mm thick stone back panel behind shelf
- Front wood laminate door and handles
- interior shelf trim
- 6mm thick stone back panel behind shelf
- Glass Sides
- Front wood laminate storage doors finish on base
- interior shelf trim
- Top door
- door locks
- Remote application
- water cooled
- central refrigeration rack
- 60 Hz components UL
- front breathing available for 1400 - 2800 models

*Oscartek® reserves the right to change, modify, discontinue, or change any features, sizes, or capacity on any model without prior notice.

OSCARTEK®
512 South Airport Blvd., South San Francisco, CA 94080
Tel: 855.885.2400 | 650.342.2400 | Fax: 650.342.7400
sales@oscartek.com | www.oscartek.com





Discover the Art of Display...

MODELS: PROVINO I DAM700, DAM1400, DAM2100, DAM2800

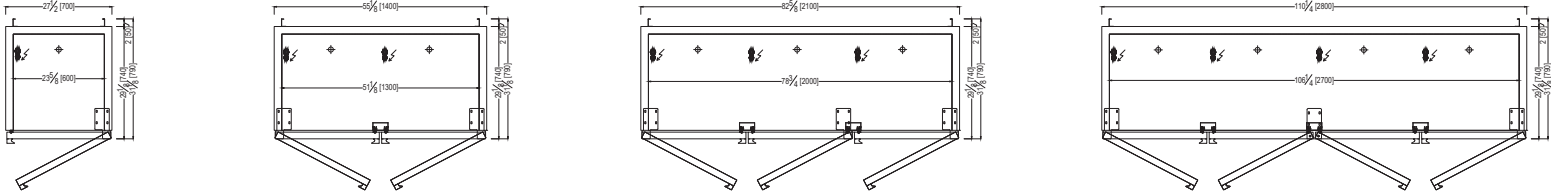
**PROVINO I
PLAN VIEWS**



ELECTRICAL LEGEND	
	REFRIGERATION LINES
	DRAIN
	POWER

**PROVINO I
REAR ELEVATIONS (OPERATOR SIDE)**

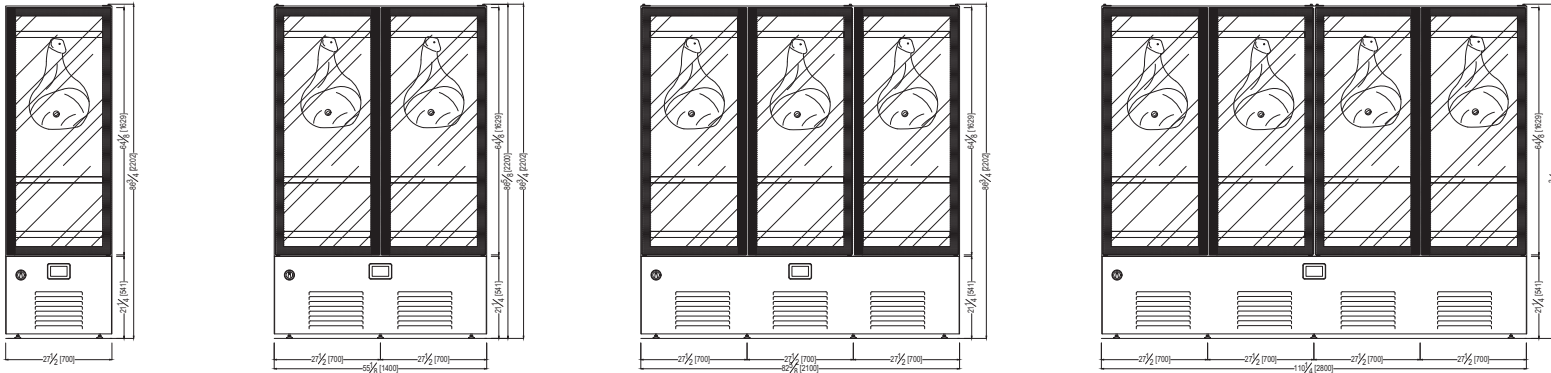

**PROVINO I - STANDARD DEPTH
SECTION VIEWS**

**STANDARD:
SELF-CONTAINED**

**OPTIONAL:
GLASS SIDE**

**STANDARD:
REMOTE**

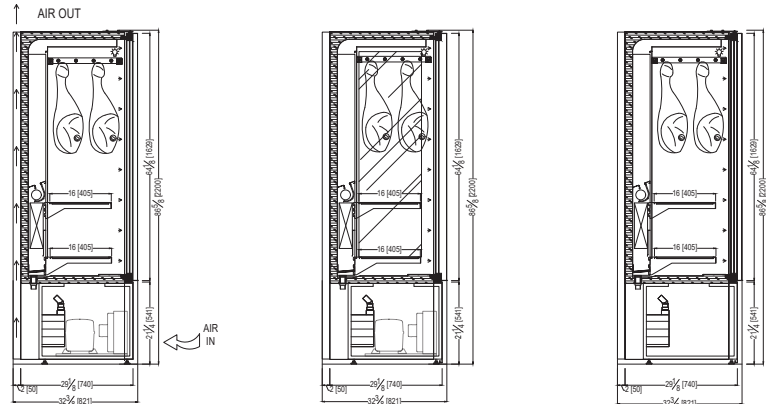

*Oscartek® reserves the right to change, modify, discontinue, or change any features, sizes, or capacity on any model without prior notice.

OSCARTEK®
512 South Airport Blvd., South San Francisco, CA 94080
Tel: 855.885.2400 | 650.342.2400 | Fax: 650.342.7400
sales@oscartek.com | www.oscartek.com





Discover the Art of Display...

Project Name: _____

Item #: _____ Quantity: _____

MODELS: PROVINO I DAM700, DAM1400, DAM2100, DAM2800

PROVINO I DRY AGED MEAT - SELF CONTAINED					
TECHNICAL FEATURES		MODELS			
Model Name (Model Code)		PROVINO I DAM700 (MUROGALA1P)	PROVINO I DAM1400 (MUROGALA2P)	PROVINO I DAM2100 (MUROGALA3P)	PROVINO I DAM2800 (MUROGALA4P)
External Dimensions (L-D-H) Inches-MM	Inches MM	*27 1/2" - 32 3/8" - 86 3/4" *700 - 821 - 2022	*55 1/8" - 32 3/8" - 86 3/4" *1400 - 821 - 2022	*82 5/8" - 32 3/8" - 86 3/4" *2100 - 821 - 2022	*110 1/4" - 32 3/8" - 86 3/4" *2800 - 821 - 2022
Crated Dimensions (L-D-H) Inches-MM	Inches MM	35" - 39" - 98" 880 - 970 - 2470	63" - 39" - 98" 1580 - 970 - 2470	90" - 39" - 98" 2280 - 970 - 2470	118" - 39" - 98" 2980 - 970 - 2470
Refrigeration	Type	Fan Assisted	Fan Assisted	Fan Assisted	Fan Assisted
Refrigeration Display Area	Type	Deck	Deck	Deck	Deck
Number of Glass Doors	#	1	2	3	4
Operating Temperature	°F	32°F to 41°F	32°F to 41°F	32°F to 41°F	32°F to 41°F
Condensing Units	#	1	2	3	4
Compressor	Nr./Type	1 / Hermetic	1 / Hermetic	1 / Hermetic	2 / Hermetic
Electric Supply	(V/Ph/Hz)	220/1/60	220/1/60	220/1/60	220/1/60
Power Consumption	(W/A)	1250/6.4	2300/11.9	3350/17	4500/22.9
Defrost	Mode/Type	Automatic	Automatic	Automatic	Automatic
Climatic Class	°F/%RH	75°F-55%RH	75°F-55%RH	75°F-55%RH	75°F-55%RH
Refrigerant Gas	Type	R290	R290	R290	R291
Net Weights	Lb	353	617	816	970
Crated Weights	Lb	413	677	876	1070

*DIMENSIONS WITH POLISHED S/S SIDES

PROVINO I DRY AGED MEAT - REMOTE					
TECHNICAL FEATURES		MODELS			
Model Name (Model Code)		PROVINO I DAM700 (MUROGALA1P)	PROVINO I DAM1400 (MUROGALA2P)	PROVINO I DAM2100 (MUROGALA3P)	PROVINO I DAM2800 (MUROGALA4P)
External Dimensions (L-D-H) Inches-MM	Inches MM	*27 1/2" - 32 3/8" - 86 3/4" *700 - 771 - 2022	*55 1/8" - 32 3/8" - 86 3/4" *1400 - 771 - 2022	*82 5/8" - 32 3/8" - 86 3/4" *2100 - 771 - 2022	*110 1/4" - 32 3/8" - 86 3/4" *2800 - 771 - 2022
Crated Dimensions (L-D-H) Inches-MM	Inches MM	35" - 39" - 98" 880 - 970 - 2470	63" - 39" - 98" 1580 - 970 - 2470	90" - 39" - 98" 2280 - 970 - 2470	118" - 39" - 98" 2980 - 970 - 2470
Refrigeration	Type	Fan Assisted	Fan Assisted	Fan Assisted	Fan Assisted
Refrigeration Display Area	Type	Deck	Deck	Deck	Deck
Number of Glass Doors	#	1	2	3	4
Operating Temperature	°F	32°F to 41°F	32°F to 41°F	32°F to 41°F	32°F to 41°F
Condensing Units	#	1	2	3	4
Compressor	Nr./Type	1 / Hermetic	1 / Hermetic	1 / Hermetic	2 / Hermetic
BTU'S @ +14°F Evap Temperature	BTU/H	2800	5100	6600	7800
Electric Supply	(V/Ph/Hz)	220/1/60	220/1/60	220/1/60	220/1/60
Power Consumption	(W/A)	1250/6.4	2300/11.9	3350/17	4500/22.9
Defrost	Mode/Type	Automatic	Automatic	Automatic	Automatic
Climatic Class	°F/%RH	75°F-55%RH	75°F-55%RH	75°F-55%RH	75°F-55%RH
Refrigerant Gas	Type	R452A	R452A	R452A	R452A
Pipe Size (Suction-Liquid)	(INCHES)	15/32" - 15/64"	35/64" - 5/16"	5/8" - 5/16"	45/64" - 25/64"
Net Weights	Lb	353	617	816	970
Crated Weights	Lb	413	677	876	1070

*DIMENSIONS WITH POLISHED S/S SIDES

*Oscartek® reserves the right to change, modify, discontinue, or change any features, sizes, or capacity on any model without prior notice.

OSCARTEK®
512 South Airport Blvd., South San Francisco, CA 94080
Tel: 855.885.2400 | 650.342.2400 | Fax: 650.342.7400
sales@oscartek.com | www.oscartek.com





Discover the Art of Display...

Project Name: _____

Item #: _____ Quantity: _____

PROVINO I DELI PASTRY

MODELS: PROVINO I DP700, DP1400, DP1400-2T, DP2100, DP2800

STANDARD FEATURES

- Solid Side
- Dual Medium Temperature Version with intermediate double glass divider
- Triple pane glass premium door
- Steel load bearing structure
- 3000°K LED lighting with dimmer switch
- Touch Control
- Ventilated cooling
- interior vertical shelf support in stainless steel
- adjustable feet
- standard steel 304A
- stainless steel interior and exterior
- Stainless steel shelves adjustable in height on racks
- programmed automatic electric defrost
- Approvals: cETLus, ETL sanitation, certified CE
- Self-contained
- Condensate evaporator pan

OPTIONS

- RAL Color Option powder coated door handles exterior and interior over stainless steel
- 6mm thick stone back panel behind shelf
- Front wood laminate door and handles
- interior shelf trim
- 6mm thick stone back panel behind shelf
- Glass Sides
- Sliding Doors
- Front wood laminate storage doors finish on base
- top door and interior shelf trim
- Top door
- door locks
- Remote application
- Top mounted condensing unit
- water cooled
- central refrigeration rack
- 60 Hz components UL
- Narrow depth
- front breathing available for 1400 - 2800 models



Provino I with optional glass side

Visit our website for optional RAL colors and Materials finishes.

[RAL Colors Website](#)

[Materials Brochure PDF](#)

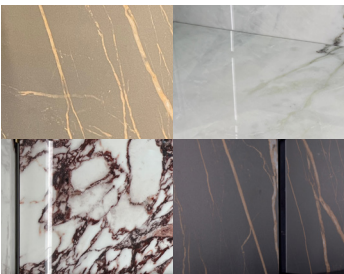

Examples of optional 6mm thick stone back panel behind shelf. For full selection see our Materials Brochure.

*Oscartek® reserves the right to change, modify, discontinue, or change any features, sizes, or capacity on any model without prior notice.



OSCARTEK®
512 South Airport Blvd., South San Francisco, CA 94080
Tel: 855.885.2400 | 650.342.2400 | Fax: 650.342.7400
sales@oscartek.com | www.oscartek.com

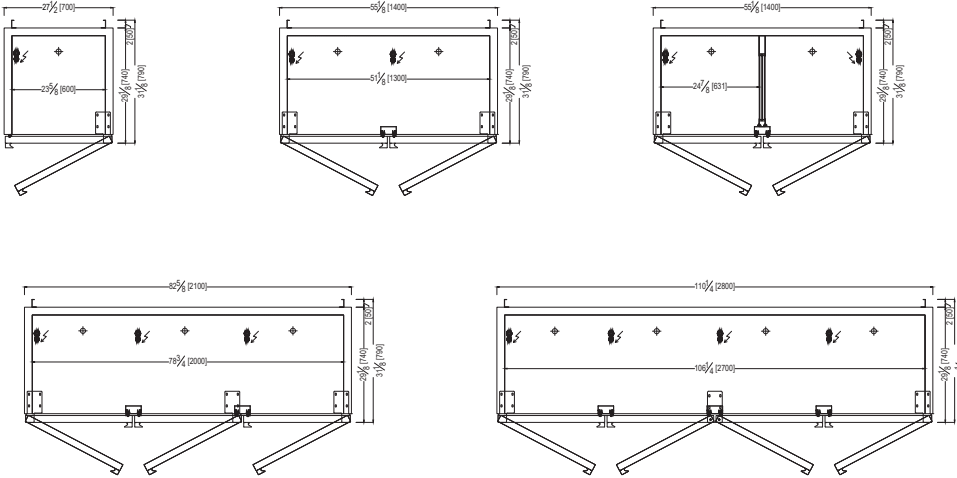

MODELS: PROVINO I DP700, DP1400, DP1400-2T, DP2100, DP2800

**PROVINO I
PLAN VIEWS**



ELECTRICAL LEGEND	
	REFRIGERATION LINES
	DRAIN
	POWER

**PROVINO I
REAR ELEVATIONS (OPERATOR SIDE)**

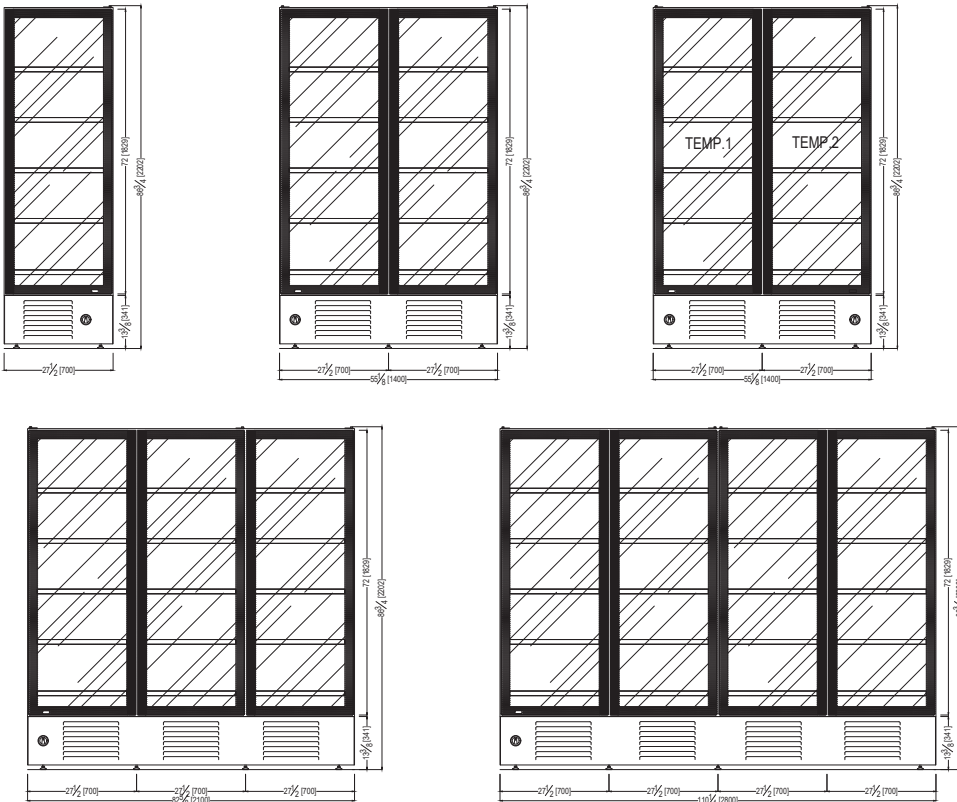

*Oscartek® reserves the right to change, modify, discontinue, or change any features, sizes, or capacity on any model without prior notice.

OSCARTEK®
512 South Airport Blvd., South San Francisco, CA 94080
Tel: 855.885.2400 | 650.342.2400 | Fax: 650.342.7400
sales@oscartek.com | www.oscartek.com



MODELS: PROVINO I DP700, DP1400, DP1400-2T, DP2100, DP2800

PROVINO I - STANDARD DEPTH SECTION VIEWS

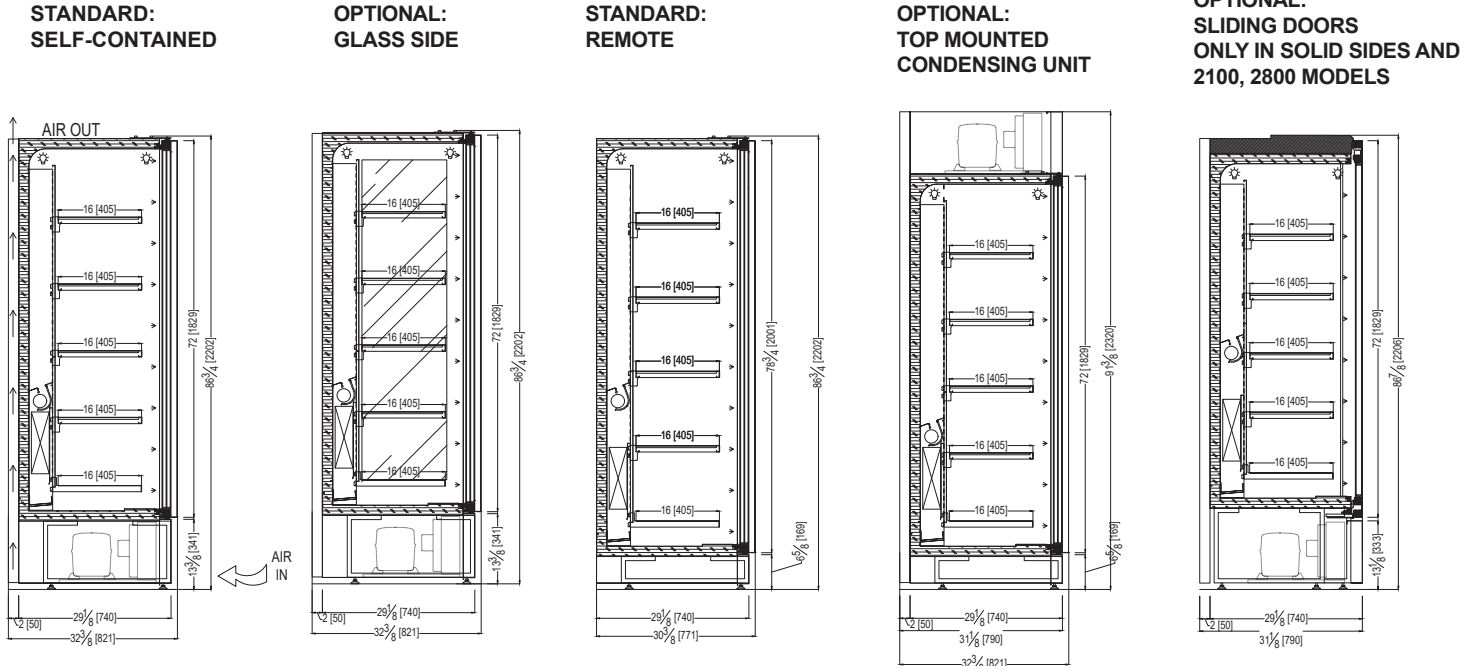

PROVINO I - NARROW DEPTH SECTION VIEWS

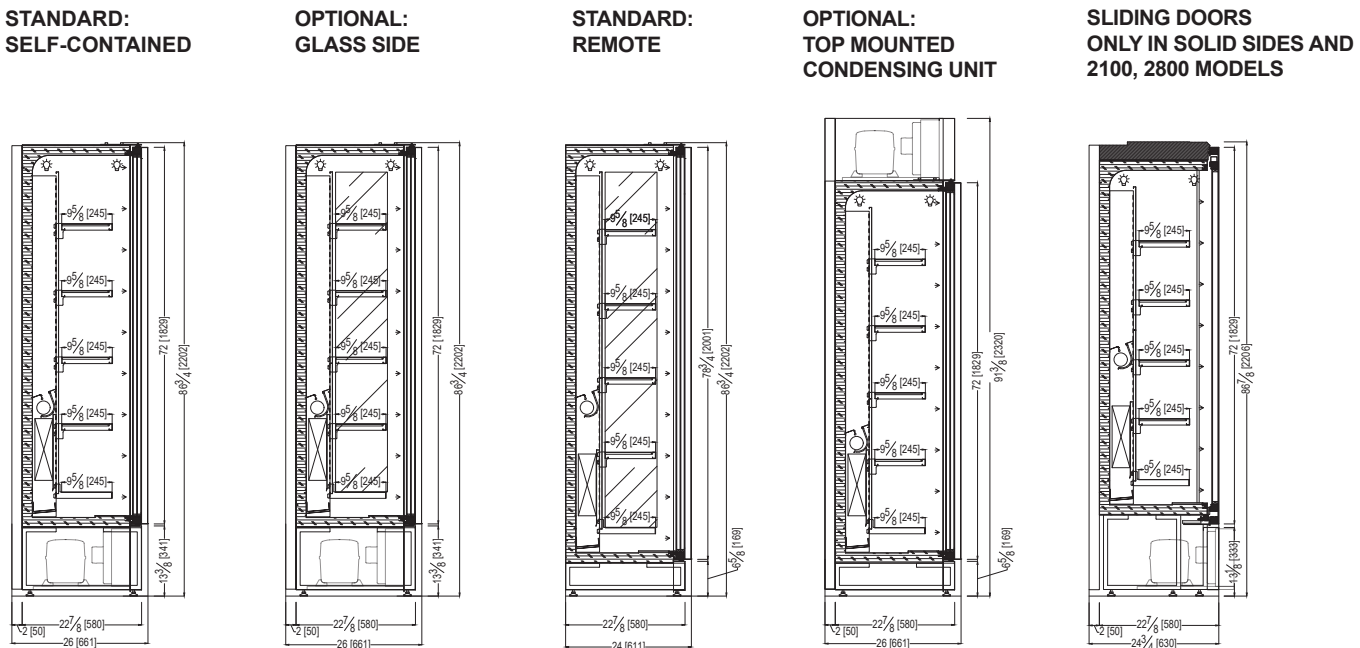

*Oscartek® reserves the right to change, modify, discontinue, or change any features, sizes, or capacity on any model without prior notice.



Discover the Art of Display...

Project Name: _____

Item #: _____ Quantity: _____

MODELS: PROVINO I DP700, DP1400, DP1400-2T, DP2100, DP2800

PROVINO I DELI PASTRY - SELF CONTAINED						
TECHNICAL FEATURES		MODELS				
Model Name (Model ETL Code)		PROVINO I DP700 (MUROGALA1P)	PROVINO I DP1400 (MUROGALA2P)	PROVINO I DP1400-2T (MUROGALA1P)X2	PROVINO I DP2100 (MUROGALA3P)	PROVINO I DP2800 (MUROGALA4P)
External Dimensions (L-D-H) Inches-MM	Inches MM	*27 1/2" - 32 3/8" - 86 3/4" *700 - 821 - 2022	*55 1/8" - 32 3/8" - 86 3/4" *1400 - 821 - 2022	*55 1/8" - 32 3/8" - 86 3/4" *1400 - 821 - 2022	*82 5/8" - 32 3/8" - 86 3/4" *2100 - 821 - 2022	*110 1/4" - 32 3/8" - 86 3/4" *2800 - 821 - 2022
Crated Dimensions (L-D-H) Inches-MM	Inches MM	35" - 39" - 98" 880 - 970 - 2470	63" - 39" - 98" 1580 - 970 - 2470	63" - 39" - 98" 1580 - 970 - 2470	90" - 39" - 98" 2280 - 970 - 2470	118" - 39" - 98" 2980 - 970 - 2470
Refrigeration	Type	Fan - Ventilated	Fan - Ventilated	Fan - Ventilated	Fan - Ventilated	Fan - Ventilated
Refrigeration Display Area	Type	Deck	Deck	Deck	Deck	Deck
Number of Glass Doors	#	1	2	2	3	4
Operating Temperature	°F	32°F to 41°F	32°F to 41°F	32°F to 41°F	32°F to 41°F	32°F to 41°F
Condensing Units	#	1	2	2	3	4
Compressor	Nr./Type	1 / Hermetic	1 / Hermetic	1 / Hermetic	1 / Hermetic	2 / Hermetic
Electric Supply	(V/Ph/Hz)	220/1/60	220/1/60	(2) 220/1/60	220/1/60	220/1/60
Power Consumption	(W/A)	700/3.9	1200/6.9	(2) 650/3.5	1700/9.5	2300/12.9
Defrost	Mode/Type	Automatic	Automatic	Automatic	Automatic	Automatic
Climatic Class	°F/%RH	75°F-55%RH	75°F-55%RH	75°F-55%RH	75°F-55%RH	75°F-55%RH
Refrigerant Gas	Type	R290	R290	R290	R290	R291
Net Weights	Lb	309	573	661	750	904
Crated Weights	Lb	369	633	721	810	964

*DIMENSIONS WITH POLISHED S/S SIDES

PROVINO I DELI PASTRY - REMOTE						
TECHNICAL FEATURES		MODELS				
Model Name (Model Code)		PROVINO I DP700 (MUROGALA1P)	PROVINO I DP1400 (MUROGALA2P)	PROVINO I DP1400-2T (MUROGALA1P)X2	PROVINO I DP2100 (MUROGALA3P)	PROVINO I DP2800 (MUROGALA4P)
External Dimensions (L-D-H) Inches-MM	Inches MM	*27 1/2" - 30 3/8" - 86 3/4" *700 - 771 - 2022	*55 1/8" - 30 3/8" - 86 3/4" *1400 - 771 - 2022	*55 1/8" - 30 3/8" - 86 3/4" *1400 - 771 - 2022	*82 5/8" - 30 3/8" - 86 3/4" *2100 - 771 - 2022	*110 1/4" - 30 3/8" - 86 3/4" *2800 - 771 - 2022
Crated Dimensions (L-D-H) Inches-MM	Inches MM	35" - 39" - 98" 880 - 970 - 2470	63" - 39" - 98" 1580 - 970 - 2470	63" - 39" - 98" 1580 - 970 - 2470	90" - 39" - 98" 2280 - 970 - 2470	118" - 39" - 98" 2980 - 970 - 2470
Refrigeration	Type	Fan - Ventilated	Fan - Ventilated	Fan - Ventilated	Fan - Ventilated	Fan - Ventilated
Refrigeration Display Area	Type	Deck	Deck	Deck	Deck	Deck
Number of Glass Doors	#	1	2	2	3	4
Operating Temperature	°F	32°F to 41°F	32°F to 41°F	32°F to 41°F	32°F to 41°F	32°F to 41°F
Condensing Units	#	1	2	2	3	4
Compressor	Nr./Type	1 / Hermetic	1 / Hermetic	1 / Hermetic	1 / Hermetic	2 / Hermetic
BTU'S @ +14°F Evap Temperature	BTU/H	2730	4980	(2) 2500	6830	7950
Electric Supply	(V/Ph/Hz)	220/1/60	220/1/60	(2) 220/1/60	220/1/60	220/1/60
Power Consumption	(W/A)	700/3.9	1200/6.9	(2) 650/3.5	1700/9.5	2300/12.9
Defrost	Mode/Type	Automatic	Automatic	Automatic	Automatic	Automatic
Climatic Class	°F/%RH	75°F-55%RH	75°F-55%RH	75°F-55%RH	75°F-55%RH	75°F-55%RH
Refrigerant Gas	Type	R452a	R452a	R452a	R452a	R452a
Pipe Size (Suction-Liquid)	(INCHES)	15/32"- 15/64"	35/64" - 5/16"	(2) 15/32"- 15/64"	5/8" - 5/16"	45/64" - 25/64"
Net Weights	Lb	309	573	661	750	904
Crated Weights	Lb	369	633	721	810	964

*DIMENSIONS WITH POLISHED S/S SIDES

*Oscartek® reserves the right to change, modify, discontinue, or change any features, sizes, or capacity on any model without prior notice.

OSCARTEK®
512 South Airport Blvd., South San Francisco, CA 94080
Tel: 855.885.2400 | 650.342.2400 | Fax: 650.342.7400
sales@oscartek.com | www.oscartek.com





Discover the Art of Display...

Project Name: _____

Item #: _____ Quantity: _____

PROVINO I FROZEN

MODELS: PROVINO I G700, G1400, G2100

STANDARD FEATURES

- Solid Side
- Dual Medium Temperature Version with intermediate double glass divider
- Triple pane glass premium door
- Steel load bearing structure
- 3000°K LED lighting with dimmer switch
- Touch Control
- Ventilated cooling
- interior vertical shelf support in stainless steel
- adjustable feet
- standard steel 304A
- stainless steel interior and exterior
- Stainless steel shelves adjustable in height on racks
- programmed automatic electric defrost
- Approvals: cETLus, ETL sanitation, certified CE
- Self-contained
- Condensate evaporator pan

OPTIONS

- RAL Color Option powder coated door handles exterior and interior over stainless steel
- 6mm thick stone back panel behind shelf
- Front wood laminate door and handles
- interior shelf trim
- 6mm thick stone back panel behind shelf
- Glass Sides
- Sliding Doors
- Front wood laminate storage doors finish on base
- top door and interior shelf trim
- Top door
- door locks
- Remote application
- Top mounted condensing unit
- water cooled
- central refrigeration rack
- 60 Hz components UL
- Narrow Depth
- Front breathing available in 1400 - 2800 models



Provino I Frozen with optional glass side

Visit our website for optional RAL colors and Materials finishes.

[RAL Colors Website](#)

[Materials Brochure PDF](#)

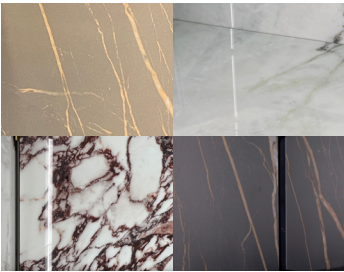

Examples of optional 6mm thick stone back panel behind shelf. For full selection see our Materials Brochure.

*Oscartek® reserves the right to change, modify, discontinue, or change any features, sizes, or capacity on any model without prior notice.



OSCARTEK®
512 South Airport Blvd., South San Francisco, CA 94080
Tel: 855.885.2400 | 650.342.2400 | Fax: 650.342.7400
sales@oscartek.com | www.oscartek.com

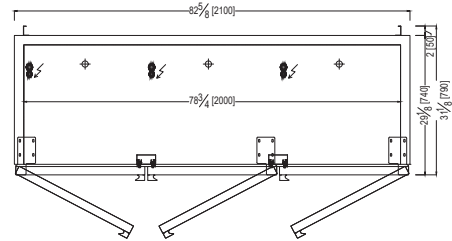
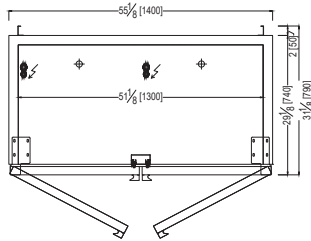
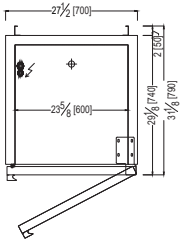

MODELS: PROVINO I G700, G1400, G2100

**PROVINO I
PLAN VIEWS**



ELECTRICAL LEGEND	
	REFRIGERATION LINES
	DRAIN
	POWER

REAR ELEVATIONS (OPERATOR SIDE)

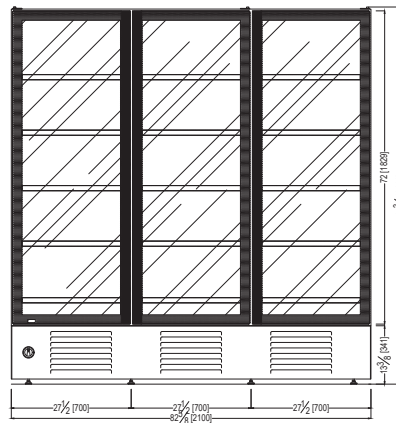
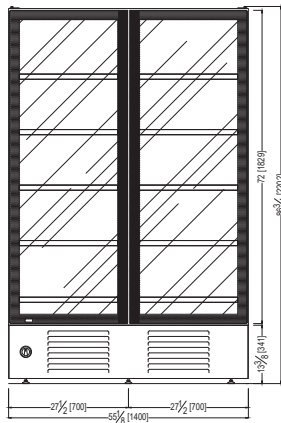
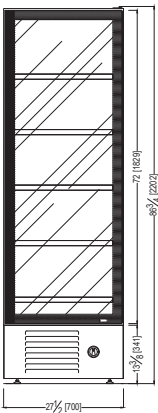

*Oscartek® reserves the right to change, modify, discontinue, or change any features, sizes, or capacity on any model without prior notice.

OSCARTEK®
512 South Airport Blvd., South San Francisco, CA 94080
Tel: 855.885.2400 | 650.342.2400 | Fax: 650.342.7400
sales@oscartek.com | www.oscartek.com



MODELS: PROVINO I G700, G1400, G2100

PROVINO I - STANDARD DEPTH SECTION VIEWS

STANDARD: SELF-CONTAINED

OPTIONAL: GLASS SIDE

STANDARD: REMOTE

OPTIONAL: TOP MOUNTED CONDENSING UNIT

OPTIONAL: SLIDING DOORS ONLY IN SOLID SIDES AND 2100, 2800 MODELS

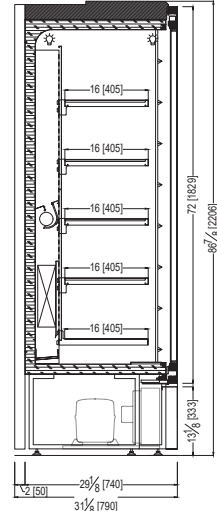
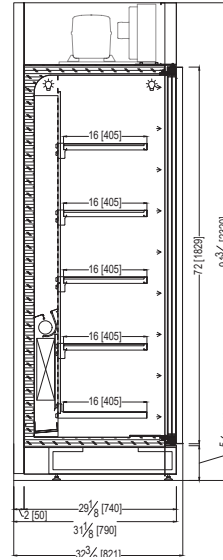
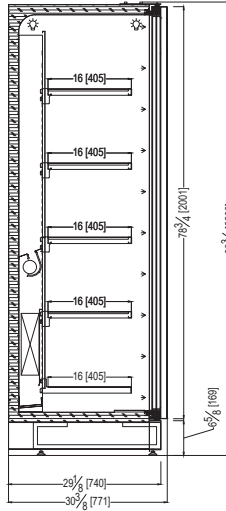
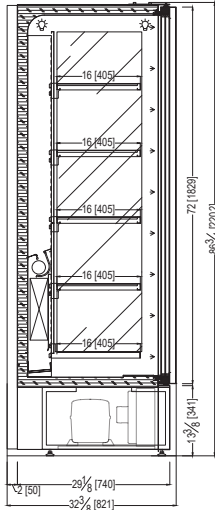
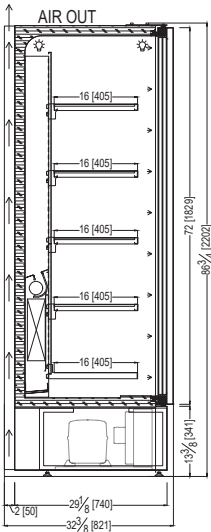

PROVINO I - NARROW DEPTH SECTION VIEWS

STANDARD: SELF-CONTAINED

OPTIONAL: GLASS SIDE

STANDARD: REMOTE

OPTIONAL: TOP MOUNTED CONDENSING UNIT

OPTIONAL: SLIDING DOORS ONLY IN SOLID SIDES AND 2100, 2800 MODELS

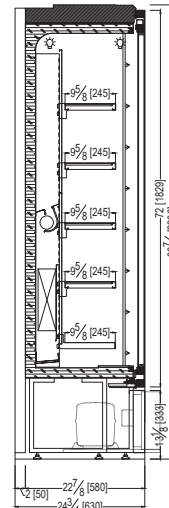
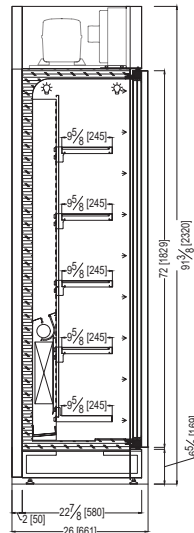
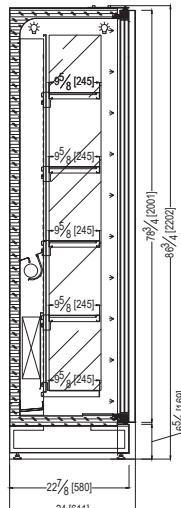
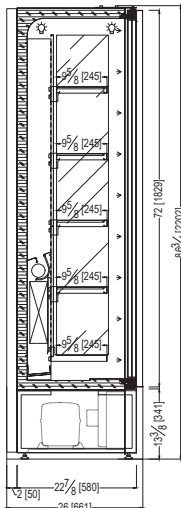
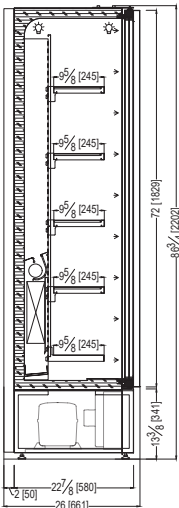

*Oscartek® reserves the right to change, modify, discontinue, or change any features, sizes, or capacity on any model without prior notice.



Discover the Art of Display...

Project Name: _____

Item #: _____ Quantity: _____

MODELS: PROVINO I G700, G1400, G2100

PROVINO I FROZEN - SELF CONTAINED				
TECHNICAL FEATURES		MODELS		
Model Name (Model ETL Code)		PROVINO I G700 (GIAGEL12)	PROVINO I G1400 (GIAGEL18)	PROVINO I G2100 (GIAGEL24)
External Dimensions (L-D-H) Inches-MM	Inches MM	*27 1/2" - 32 3/8" - 86 3/4" *700 - 821 - 2022	*55 1/8" - 32 3/8" - 86 3/4" *1400 - 821 - 2022	*82 5/8" - 32 3/8" - 86 3/4" *2100 - 821 - 2022
Crated Dimensions (L-D-H) Inches-MM	Inches MM	35" - 39" - 98" 880 - 970 - 2470	63" - 39" - 98" 1580 - 970 - 2470	90" - 39" - 98" 2280 - 970 - 2470
Refrigeration	Type	Fan - Ventilated	Fan - Ventilated	Fan - Ventilated
Refrigeration Display Area	Type	Deck	Deck	Deck
Number of Glass Doors	#	1	2	3
Operating Temperature	°F	0°F to 5°F	0°F to 5°F	0°F to 5°F
Condensing Units	#	1	2	3
Compressor	Nr./Type	1 / Hermetic	1 / Hermetic	1 / Hermetic
Electric Supply	(V/Ph/Hz)	220/1/60	220/1/60	220/1/60
Power Consumption	(W/A)	1300/8.9	2400/16.5	3600/24.5
Defrost	Mode/Type	Automatic	Automatic	Automatic
Climatic Class	°F/%RH	75°F-55%RH	75°F-55%RH	75°F-55%RH
Refrigerant Gas	Type	R290	R290	R290
Net Weights	Lb	353	617	816
Crated Weights	Lb	413	677	876

*DIMENSIONS WITH POLISHED S/S SIDES

PROVINO I FROZEN - REMOTE				
TECHNICAL FEATURES		MODELS		
Model Name (Model Code)		PROVINO I G700 (GIAGEL12)	PROVINO I G1400 (GIAGEL18)	PROVINO I G2100 (GIAGEL24)
External Dimensions (L-D-H) Inches-MM	Inches MM	*27 1/2" - 30 3/8" - 86 3/4" *700 - 771 - 2022	*55 1/8" - 30 3/8" - 86 3/4" *1400 - 771 - 2022	*82 5/8" - 30 3/8" - 86 3/4" *2100 - 771 - 2022
Crated Dimensions (L-D-H) Inches-MM	Inches MM	35" - 39" - 98" 880 - 970 - 2470	63" - 39" - 98" 1580 - 970 - 2470	90" - 39" - 98" 2280 - 970 - 2470
Refrigeration	Type	Fan - Ventilated	Fan - Ventilated	Fan - Ventilated
Refrigeration Display Area	Type	Deck	Deck	Deck
Number of Glass Doors	#	1	2	3
Operating Temperature	°F	-5°F to 5°F	-5°F to 5°F	-5°F to 5°F
Condensing Units	#	1	2	3
Compressor	Nr./Type	1 / Hermetic	1 / Hermetic	1 / Hermetic
BTU'S @ -31°F Evap Temperature	BTU/H	2730	4610	6150
Electric Supply	(V/Ph/Hz)	220/1/60	220/1/60	220/1/60
Power Consumption	(W/A)	1300/8.9	2400/16.5	3600/24.5
Defrost	Mode/Type	Automatic	Automatic	Automatic
Climatic Class	°F/%RH	75°F-55%RH	75°F-55%RH	75°F-55%RH
Refrigerant Gas	Type	R452A	R452A	R452A
Pipe Size (Suction-Liquid)	(INCHES)	45/64"- 25/64"	55/64" - 25/64"	55/64" - 15/32"
Net Weights	Lb	353	617	816
Crated Weights	Lb	413	677	876

*DIMENSIONS WITH POLISHED S/S SIDES

*Oscartek® reserves the right to change, modify, discontinue, or change any features, sizes, or capacity on any model without prior notice.

OSCARTEK®
512 South Airport Blvd., South San Francisco, CA 94080
Tel: 855.885.2400 | 650.342.2400 | Fax: 650.342.7400
sales@oscartek.com | www.oscartek.com





Provino I Red Meat with custom finish

Visit our website for optional RAL colors and Materials finishes.

[RAL Colors Website](#)

[Materials Brochure PDF](#)

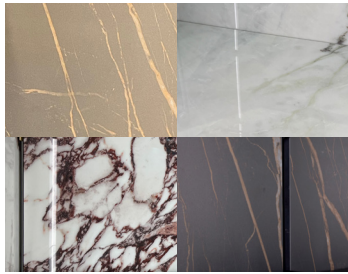

Examples of optional 6mm thick stone back panel behind shelf. For full selection see our Materials Brochure.

Project Name: _____

Item #: _____ Quantity: _____

PROVINO I RED MEAT

MODELS: PROVINO I RM700, RM1400, RM1400-2T, RM2100, RM2800

STANDARD FEATURES

- Solid Side
- Dual Medium Temperature Version with intermediate double glass divider
- Triple pane glass premium door
- Steel load bearing structure
- 3000°K LED lighting with dimmer switch
- Touch Control
- Ventilated cooling
- interior vertical shelf support in stainless steel
- adjustable feet
- standard steel 304A
- stainless steel interior and exterior
- Stainless steel shelves adjustable in height on racks
- programmed automatic electric defrost
- Approvals: cETLus, ETL sanitation, certified CE
- Self-contained
- Condensate evaporator pan

OPTIONS

- RAL Color Option powder coated door handles exterior and interior over stainless steel
- 6mm thick stone back panel behind shelf
- Front wood laminate door and handles
- interior shelf trim
- 6mm thick stone back panel behind shelf
- Glass Sides
- Sliding Doors
- Front wood laminate storage doors finish on base
- top door and interior shelf trim
- Top door
- door locks
- Remote application
- Top mounted condensing unit
- water cooled
- central refrigeration rack
- 60 Hz components UL
- Narrow depth
- front breathing available for 1400 - 2800 models



*Oscartek® reserves the right to change, modify, discontinue, or change any features, sizes, or capacity on any model without prior notice.

Discover the Art of Display...

MODELS: PROVINO I RM700, RM1400, RM1400-2T, RM2100, RM2800

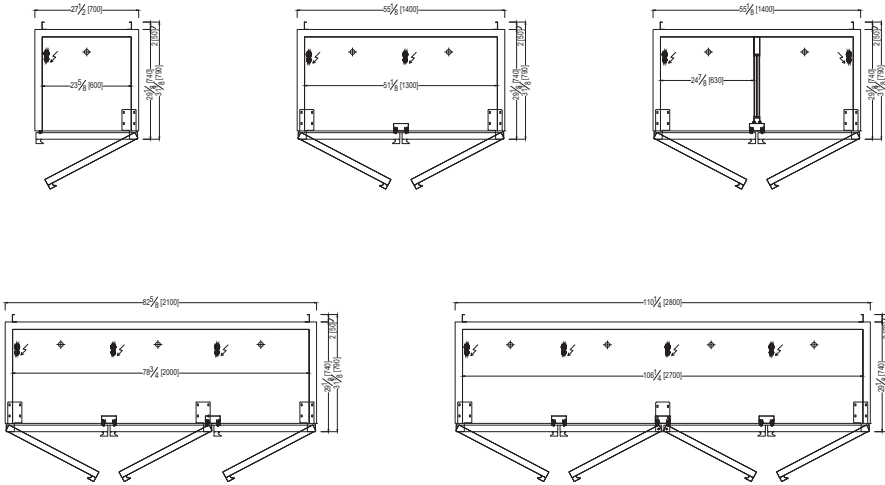
**PROVINO I
PLAN VIEWS**



ELECTRICAL LEGEND	
	REFRIGERATION LINES
	DRAIN
	POWER

**PROVINO I
REAR ELEVATIONS (OPERATOR SIDE)**

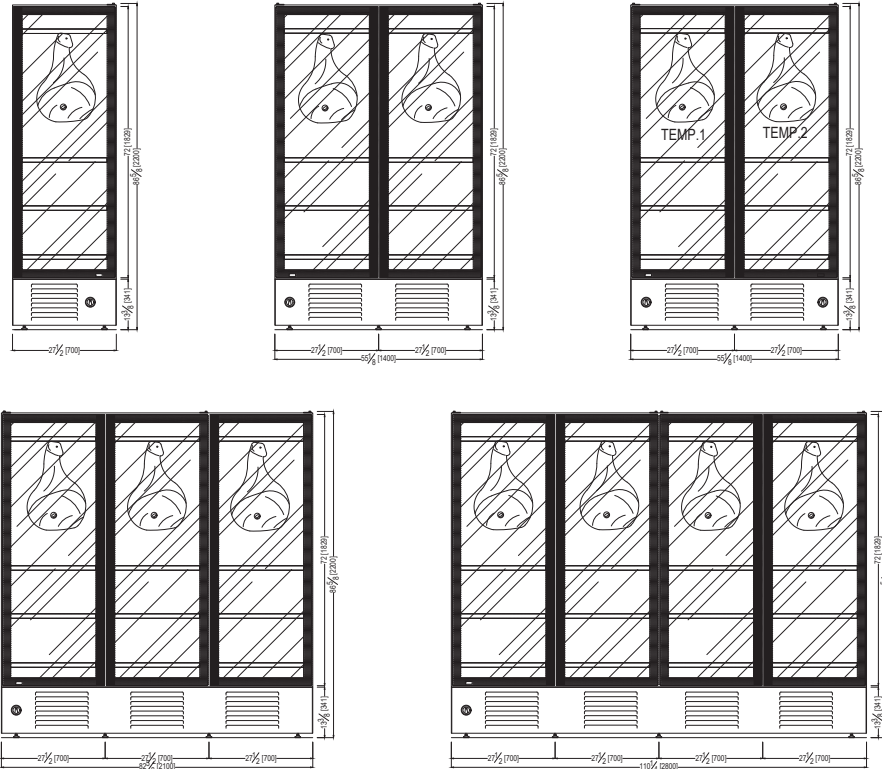

*Oscartek® reserves the right to change, modify, discontinue, or change any features, sizes, or capacity on any model without prior notice.

OSCARTEK®
512 South Airport Blvd., South San Francisco, CA 94080
Tel: 855.885.2400 | 650.342.2400 | Fax: 650.342.7400
sales@oscartek.com | www.oscartek.com



MODELS: PROVINO I RM700, RM1400, RM1400-2T, RM2100, RM2800

PROVINO I - STANDARD DEPTH SECTION VIEWS

**STANDARD:
SELF-CONTAINED**

**OPTIONAL:
GLASS SIDE**

**STANDARD:
REMOTE**

**OPTIONAL:
TOP MOUNTED
CONDENSING UNIT**

**OPTIONAL:
SLIDING DOORS
ONLY IN SOLID SIDES AND
2100, 2800 MODELS**

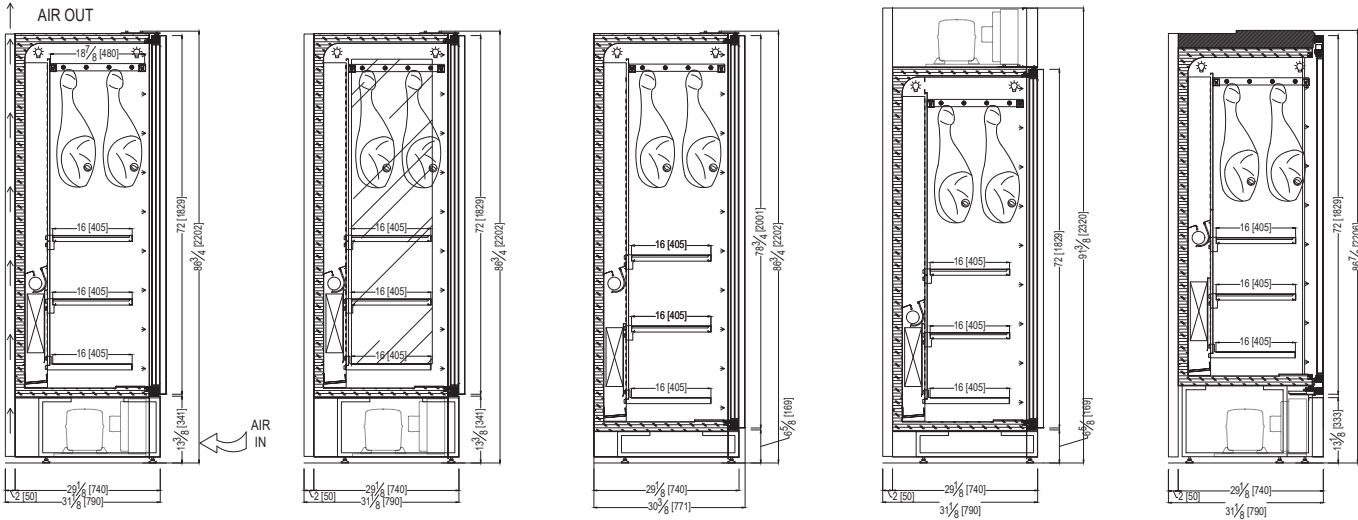

PROVINO I - NARROW DEPTH SECTION VIEWS

**STANDARD:
SELF-CONTAINED**

**OPTIONAL:
GLASS SIDE**

**STANDARD:
REMOTE**

**OPTIONAL:
TOP MOUNTED
CONDENSING UNIT**

**OPTIONAL:
SLIDING DOORS
ONLY IN SOLID SIDES AND
2100, 2800 MODELS**

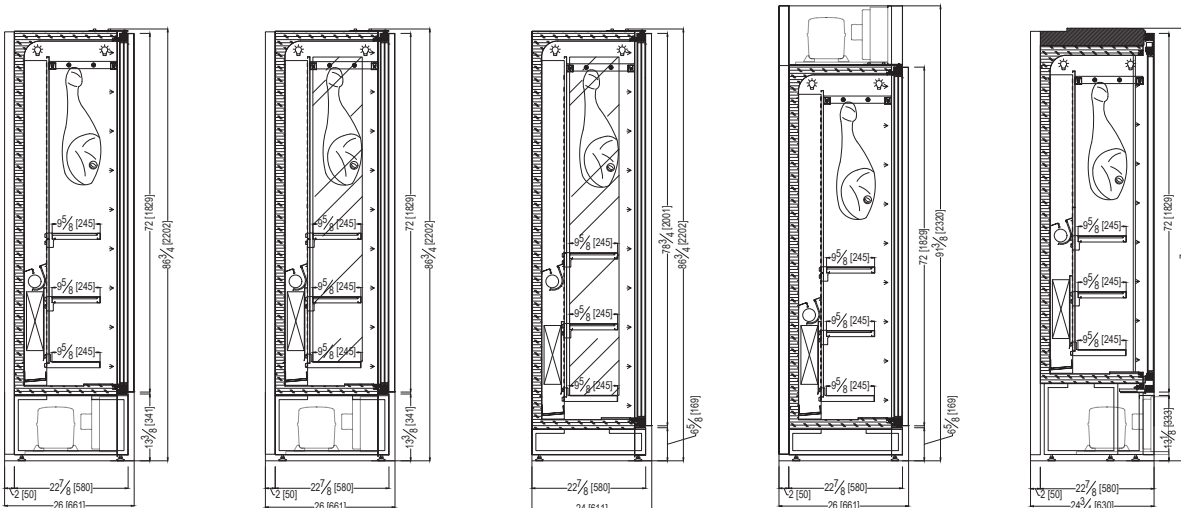

*Oscartek® reserves the right to change, modify, discontinue, or change any features, sizes, or capacity on any model without prior notice.

OSCARTEK®
512 South Airport Blvd., South San Francisco, CA 94080
Tel: 855.885.2400 | 650.342.2400 | Fax: 650.342.7400
sales@oscartek.com | www.oscartek.com





Discover the Art of Display...

Project Name: _____

Item #: _____ Quantity: _____

MODELS: PROVINO I RM700, RM1400, RM1400-2T, RM2100, RM2800

PROVINO I RED MEAT - SELF CONTAINED						
TECHNICAL FEATURES		MODELS				
Model Name (Model ETL Code)		PROVINO I RM700 (MUROGALA1P)	PROVINO I RM1400 (MUROGALA2P)	PROVINO I RM1400-2T (MUROGALA1P)X2	PROVINO I RM2100 (MUROGALA3P)	PROVINO I RM2800 (MUROGALA4P)
External Dimensions (L-D-H)	Inches	*27 1/2" - 32 3/8" - 86 3/4"	*55 1/8" - 32 3/8" - 86 3/4"	*55 1/8" - 32 3/8" - 86 3/4"	*82 5/8" - 32 3/8" - 86 3/4"	*110 1/4" - 32 3/8" - 86 3/4"
	Inches-MM	*700 - 821 - 2022	*1400 - 821 - 2022	*1400 - 821 - 2022	*2100 - 821 - 2022	*2800 - 821 - 2022
Crated Dimensions (L-D-H)	Inches	35" - 39" - 98"	63" - 39" - 98"	63" - 39" - 98"	90" - 39" - 98"	118" - 39" - 98"
	Inches-MM	880 - 970 - 2470	1580 - 970 - 2470	1580 - 970 - 2470	2280 - 970 - 2470	2980 - 970 - 2470
Refrigeration	Type	Fan - Ventilated	Fan - Ventilated	Fan - Ventilated	Fan - Ventilated	Fan - Ventilated
Refrigeration Display Area	Type	Deck	Deck	Deck	Deck	Deck
Number of Glass Doors	#	1	2	2	3	4
Operating Temperature	°F	32°F to 41°F	32°F to 41°F	32°F to 41°F	32°F to 41°F	32°F to 41°F
Condensing Units	#	1	2	2	3	4
Compressor	Nr./Type	1 / Hermetic	1 / Hermetic	1 / Hermetic	1 / Hermetic	2 / Hermetic
Electric Supply	(V/Ph/Hz)	220/1/60	220/1/60	(2) 220/1/60	220/1/60	220/1/60
Power Consumption	(W/A)	700/3.9	1200/6.9	(2) 650/3.5	1700/9.5	2300/12.9
Defrost	Mode/Type	Automatic	Automatic	Automatic	Automatic	Automatic
Climatic Class	°F/%RH	75°F-55%RH	75°F-55%RH	75°F-55%RH	75°F-55%RH	75°F-55%RH
Refrigerant Gas	Type	R290	R290	R290	R290	R291
Net Weights	Lb	309	573	661	750	904
Crated Weights	Lb	369	633	721	810	964

*DIMENSIONS WITH POLISHED S/S SIDES

PROVINO I RED MEAT - REMOTE						
TECHNICAL FEATURES		MODELS				
Model Name (Model Code)		PROVINO I RM700 (MUROGALA1P)	PROVINO I RM1400 (MUROGALA2P)	PROVINO I RM1400-2T (MUROGALA1P)X2	PROVINO I RM2100 (MUROGALA3P)	PROVINO I RM2800 (MUROGALA4P)
External Dimensions (L-D-H)	Inches	*27 1/2" - 30 3/8" - 86 3/4"	*55 1/8" - 30 3/8" - 86 3/4"	*55 1/8" - 30 3/8" - 86 3/4"	*82 5/8" - 30 3/8" - 86 3/4"	*110 1/4" - 30 3/8" - 86 3/4"
	Inches-MM	*700 - 771 - 2022	*1400 - 771 - 2022	*1400 - 771 - 2022	*2100 - 771 - 2022	*2800 - 771 - 2022
Crated Dimensions (L-D-H)	Inches	35" - 39" - 98"	63" - 39" - 98"	63" - 39" - 98"	90" - 39" - 98"	118" - 39" - 98"
	Inches-MM	880 - 970 - 2470	1580 - 970 - 2470	1580 - 970 - 2470	2280 - 970 - 2470	2980 - 970 - 2470
Refrigeration	Type	Fan - Ventilated	Fan - Ventilated	Fan - Ventilated	Fan - Ventilated	Fan - Ventilated
Refrigeration Display Area	Type	Deck	Deck	Deck	Deck	Deck
Number of Glass Doors	#	1	2	2	3	4
Operating Temperature	°F	32°F to 41°F	32°F to 41°F	32°F to 41°F	32°F to 41°F	32°F to 41°F
Condensing Units	#	1	2	2	3	4
Compressor	Nr./Type	1 / Hermetic	1 / Hermetic	1 / Hermetic	1 / Hermetic	2 / Hermetic
BTU'S @ +14°F Evap Temperature	BTU/H	2730	4980	(2) 2500	6830	7950
Electric Supply	(V/Ph/Hz)	220/1/60	220/1/60	(2) 220/1/60	220/1/60	220/1/60
Power Consumption	(W/A)	700/3.9	1200/6.9	(2) 650/3.5	1700/9.5	2300/12.9
Defrost	Mode/Type	Automatic	Automatic	Automatic	Automatic	Automatic
Climatic Class	°F/%RH	75°F-55%RH	75°F-55%RH	75°F-55%RH	75°F-55%RH	75°F-55%RH
Refrigerant Gas	Type	R452a	R452a	R452a	R452a	R452a
Pipe Size (Suction-Liquid)	(INCHES)	15/32" - 15/64"	35/64" - 5/16"	(2) 15/32" - 15/64"	5/8" - 5/16"	45/64" - 25/64"
Net Weights	Lb	309	573	661	750	904
Crated Weights	Lb	369	633	721	810	964

*DIMENSIONS WITH POLISHED S/S SIDES

*Oscartek® reserves the right to change, modify, discontinue, or change any features, sizes, or capacity on any model without prior notice.

OSCARTEK®
 512 South Airport Blvd., South San Francisco, CA 94080
 Tel: 855.885.2400 | 650.342.2400 | Fax: 650.342.7400
 sales@oscartek.com | www.oscartek.com





Discover the Art of Display...

Project Name: _____

Item #: _____ Quantity: _____

PROVINO I WINE

MODELS: PROVINO I W700, W1400, W1400-2T, W2100, W2800

STANDARD FEATURES

- Solid Side
- Dual Medium Temperature Version with intermediate double glass divider
- Triple pane glass premium door
- Steel load bearing structure
- 3000°K LED lighting with dimmer switch
- Touch Control
- Ventilated cooling
- interior vertical shelf support in stainless steel
- adjustable feet
- standard steel 304A
- stainless steel interior and exterior
- Stainless steel shelves adjustable in height on racks (4 shelves included per door)
- programmed automatic electric defrost
- Approvals: cETLus, ETL sanitation, certified CE
- Self-contained
- Condensate evaporator pan



Provino I with optional glass side

Visit our website for optional RAL colors and Materials finishes.

[RAL Colors Website](#)

[Materials Brochure PDF](#)

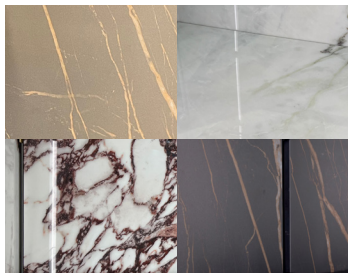

Examples of optional 6mm thick stone back panel behind shelf. For full selection see our Materials Brochure.

OPTIONS

- RAL Color Option powder coated door handles exterior and interior over stainless
- Front wood laminate door and handles
- interior shelf trim
- 6mm thick stone back panel behind shelf
- Glass Sides
- Sliding Doors
- Front wood laminate storage doors finish on base top door and interior shelf trim
- Top door
- door locks
- Remote application
- Top mounted condensing unit
- water cooled
- central refrigeration rack
- 60 Hz components UL
- 6mm thick stone back panel behind shelf
- Glass Sides
- Narrow Depth
- front breathing available for 1400L - 2800L models
- **Shelf options:** horizontal, slanted, combination (see section views)

*Oscartek® reserves the right to change, modify, discontinue, or change any features, sizes, or capacity on any model without prior notice.



OSCARTEK®
512 South Airport Blvd., South San Francisco, CA 94080
Tel: 855.885.2400 | 650.342.2400 | Fax: 650.342.7400
sales@oscartek.com | www.oscartek.com

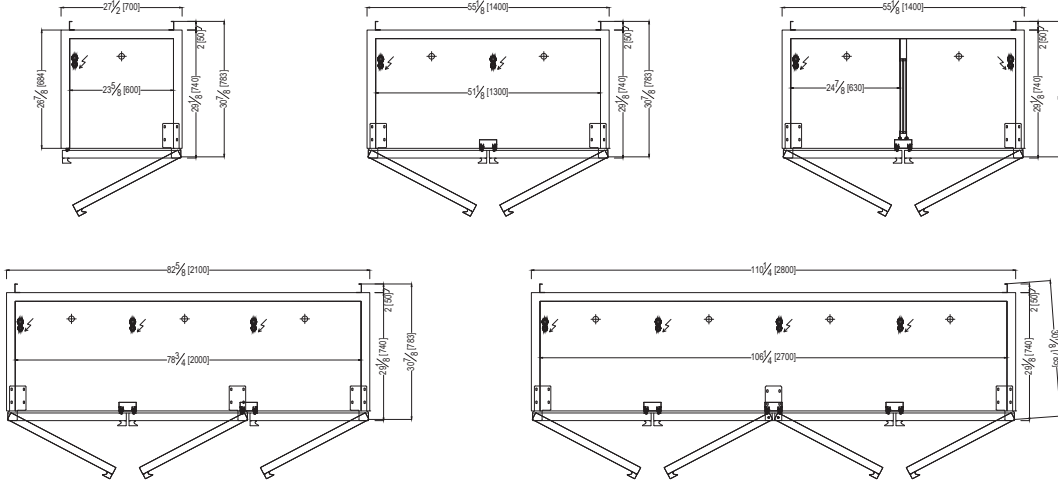

MODELS: PROVINO I W700, W1400, W1400-2T, W2100, W2800

**PROVINO I
PLAN VIEWS**



ELECTRICAL LEGEND	
	REFRIGERATION LINES
	DRAIN
	POWER

**PROVINO I
REAR ELEVATIONS (OPERATOR SIDE)**

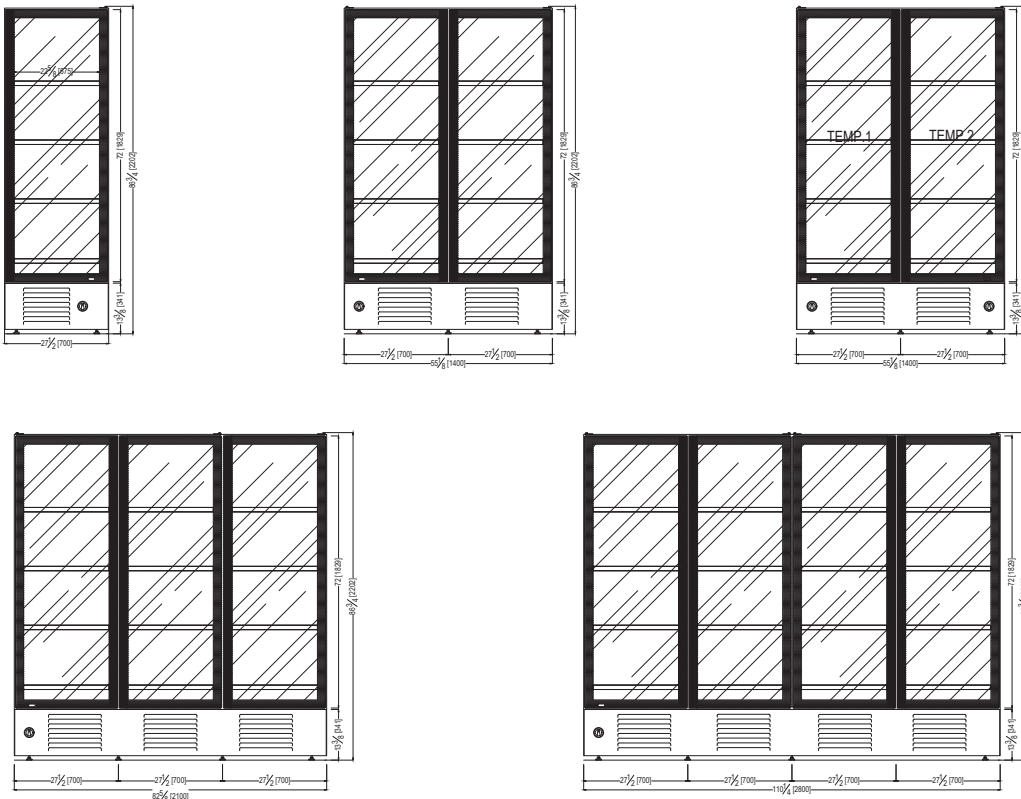

*Oscartek® reserves the right to change, modify, discontinue, or change any features, sizes, or capacity on any model without prior notice.

OSCARTEK®
512 South Airport Blvd., South San Francisco, CA 94080
Tel: 855.885.2400 | 650.342.2400 | Fax: 650.342.7400
sales@oscartek.com | www.oscartek.com





Discover the Art of Display...

Project Name: _____

Item #: _____ Quantity: _____

MODELS: PROVINO I W700, W1400, W1400-2T, W2100, W2800

PROVINO I - STANDARD DEPTH SECTION VIEWS

STANDARD: SELF-CONTAINED

STANDARD: REMOTE WITH VERTICAL SHELVES

OPTIONAL: GLASS SIDE

OPTIONAL: TOP MOUNTED CONDENSING UNIT

OPTIONAL: SLIDING DOORS ONLY IN SOLID SIDES & 2100, 2800 MODELS

OPTIONAL: SLANTED SHELVES

OPTIONAL: HORIZONTAL SHELVES

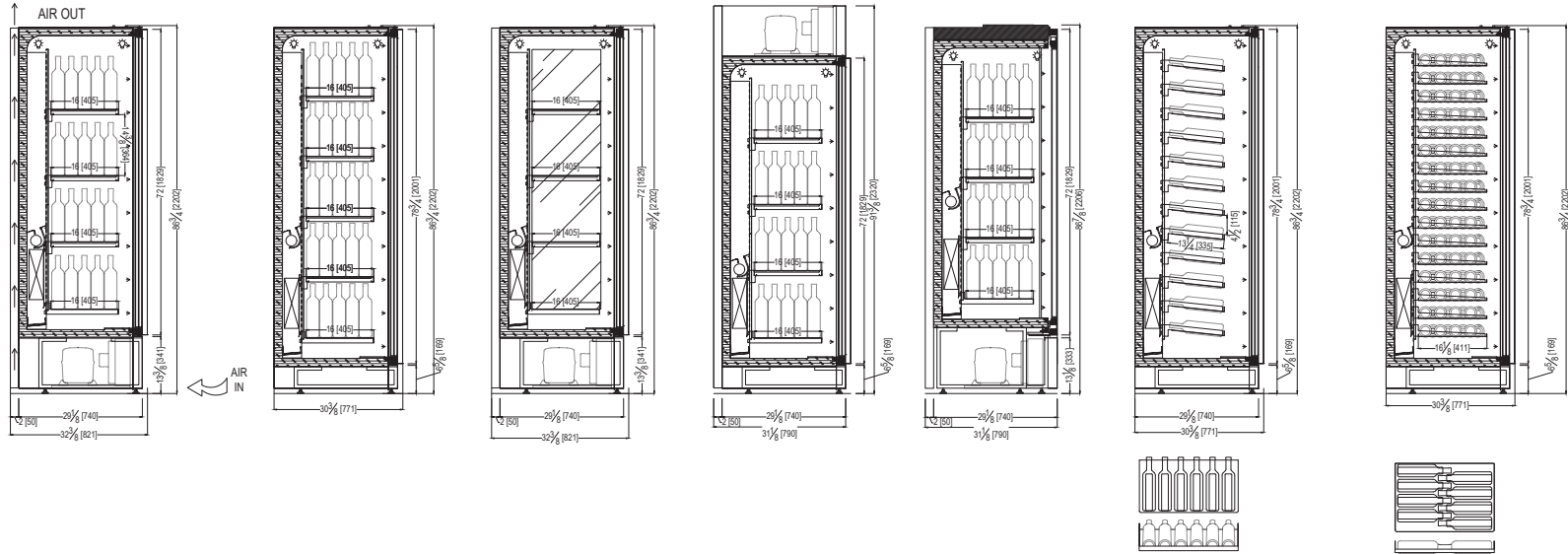

PROVINO I - NARROW DEPTH SECTION VIEWS

STANDARD: SELF-CONTAINED

STANDARD: REMOTE WITH VERTICAL SHELVES

OPTIONAL: GLASS SIDE

OPTIONAL: TOP MOUNTED CONDENSING UNIT

OPTIONAL: SLIDING DOORS ONLY IN SOLID SIDES AND 2100, 2800 MODELS

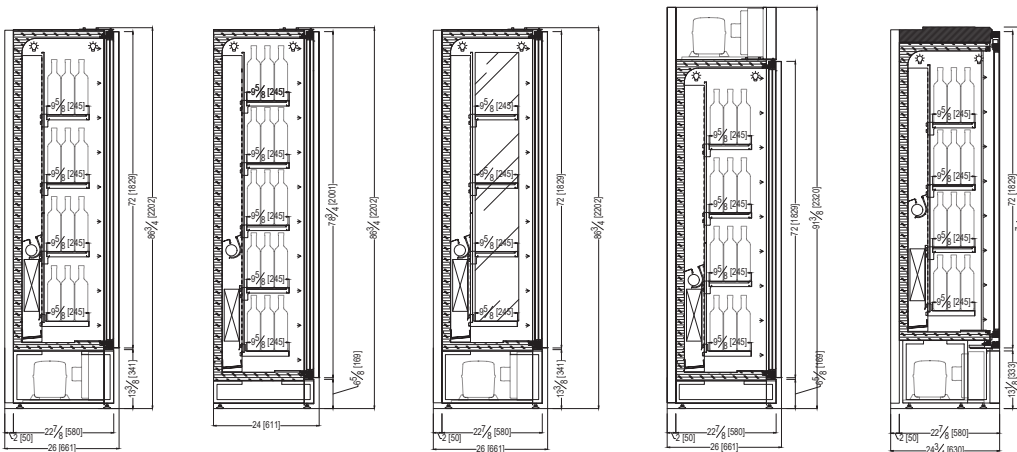

*Oscartek® reserves the right to change, modify, discontinue, or change any features, sizes, or capacity on any model without prior notice.

OSCARTEK®
 512 South Airport Blvd., South San Francisco, CA 94080
 Tel: 855.885.2400 | 650.342.2400 | Fax: 650.342.7400
 sales@oscartek.com | www.oscartek.com





Project Name: _____

Item #: _____ Quantity: _____

Discover the Art of Display...

MODELS: PROVINO I W700, W1400, W1400-2T, W2100, W2800

PROVINO I WINE - SELF CONTAINED						
TECHNICAL FEATURES		MODELS				
Model Name (Model ETL Code)		PROVINO I W700 (MUROGALA1P)	PROVINO I W1400 (MUROGALA2P)	PROVINO I W1400-2T (MUROGALA1P) X2	PROVINO I W2100 (MUROGALA3P)	PROVINO I W2800 (MUROGALA4P)
External Dimensions (L-D-H) Inches-MM	Inches MM	*27 1/2" - 32 3/8" - 86 3/4" *700 - 821 - 2022	*55 1/8" - 32 3/8" - 86 3/4" *1400 - 821 - 2022	*55 1/8" - 32 3/8" - 86 3/4" *1400 - 821 - 2022	*82 5/8" - 32 3/8" - 86 3/4" *2100 - 821 - 2022	*110 1/4" - 32 3/8" - 86 3/4" *2800 - 821 - 2022
Crated Dimensions (L-D-H) Inches-MM	Inches MM	35" - 39" - 98" 880 - 970 - 2470	63" - 39" - 98" 1580 - 970 - 2470	63" - 39" - 98" 1580 - 970 - 2470	90" - 39" - 98" 2280 - 970 - 2470	118" - 39" - 98" 2980 - 970 - 2470
Refrigeration	Type	Fan - Ventilated	Fan - Ventilated	Fan - Ventilated	Fan - Ventilated	Fan - Ventilated
Refrigeration Display Area	Type	Deck	Deck	Deck	Deck	Deck
Number of Glass Doors	#	1	2	2	3	4
Wine Rack Shelves	bottle orientation: #	Vertical: 4 Horizontal: 14 Slanted: 11	Vertical: 8 Horizontal: 28 Slanted: 22	Vertical: (2) 4 Horizontal: (2) 14 Slanted: (2) 11	Vertical: 12 Horizontal: 42 Slanted: 33	Vertical: 16 Horizontal: 56 Slanted: 44
	bottle orientation: #	Vertical: 140 Horizontal: 112 Slanted: 66	Vertical: 300 Horizontal: 224 Slanted: 132	Vertical: (2) 140 Horizontal: (2) 112 Slanted: (2) 66	Vertical: 480 Horizontal: 336 Slanted: 198	Vertical: 660 Horizontal: 448 Slanted: 308
Bottle Capacity (STD size)						
Operating Temperature	°F	45°F to 58°F	45°F to 58°F	45°F to 58°F	45°F to 58°F	45°F to 58°F
Condensing Units	#	1	2	2	3	4
Compressor	Nr./Type	1 / Hermetic	1 / Hermetic	1 / Hermetic	1 / Hermetic	2 / Hermetic
Electric Supply	(V/Ph/Hz)	220/1/60	220/1/60	(2) 220/1/60	220/1/60	220/1/60
Power Consumption	(W/A)	700/3.9	1200/6.9	(2) 650/3.5	1700/9.5	2300/12.9
Defrost	Mode/Type	Automatic	Automatic	Automatic	Automatic	Automatic
Climatic Class	°F/%RH	75°F-55%RH	75°F-55%RH	75°F-55%RH	75°F-55%RH	75°F-55%RH
Refrigerant Gas	Type	R290	R290	R290	R290	R291
Net Weights	Lb	309	573	661	750	904
Crated Weights	Lb	369	633	721	810	964

*DIMENSIONS WITH POLISHED S/S SIDES

PROVINO I WINE - REMOTE						
TECHNICAL FEATURES		MODELS				
Model Name (Model Code)		PROVINO I W700 (MUROGALA1P)	PROVINO I W1400 (MUROGALA2P)	PROVINO I W1400-2T (MUROGALA1P) X2	PROVINO I W2100 (MUROGALA3P)	PROVINO I W2800 (MUROGALA4P)
External Dimensions (L-D-H) Inches-MM	Inches MM	*27 1/2" - 30 3/8" - 86 3/4" *700 - 771 - 2022	*55 1/8" - 30 3/8" - 86 3/4" *1400 - 771 - 2022	*55 1/8" - 30 3/8" - 86 3/4" *1400 - 771 - 2022	*82 5/8" - 30 3/8" - 86 3/4" *2100 - 771 - 2022	*110 1/4" - 30 3/8" - 86 3/4" *2800 - 771 - 2022
Crated Dimensions (L-D-H) Inches-MM	Inches MM	35" - 39" - 98" 880 - 970 - 2470	63" - 39" - 98" 1580 - 970 - 2470	63" - 39" - 98" 1580 - 970 - 2470	90" - 39" - 98" 2280 - 970 - 2470	118" - 39" - 98" 2980 - 970 - 2470
Refrigeration	Type	Fan - Ventilated	Fan - Ventilated	Fan - Ventilated	Fan - Ventilated	Fan - Ventilated
Refrigeration Display Area	Type	Deck	Deck	Deck	Deck	Deck
Number of Glass Doors	#	1	2	2	3	4
Wine Rack Shelves	bottle orientation: #	Vertical: 5 Horizontal: 16 Slanted: 12	Vertical: 10 Horizontal: 32 Slanted: 24	Vertical: (2) 5 Horizontal: (2) 16 Slanted: (2) 12	Vertical: 15 Horizontal: 45 Slanted: 36	Vertical: 20 Horizontal: 64 Slanted: 48
	bottle orientation: #	Vertical: 175 Horizontal: 128 Slanted: 72	Vertical: 375 Horizontal: 256 Slanted: 144	Vertical: (2) 175 Horizontal: (2) 128 Slanted: (2) 72	Vertical: 600 Horizontal: 384 Slanted: 216	Vertical: 825 Horizontal: 512 Slanted: 336
Bottle Capacity (STD size)						
Operating Temperature	°F	45°F to 58°F	45°F to 58°F	45°F to 58°F	45°F to 58°F	45°F to 58°F
Condensing Units	#	1	2	2	3	4
Compressor	Nr./Type	1 / Hermetic	1 / Hermetic	1 / Hermetic	1 / Hermetic	2 / Hermetic
BTU'S @ +14°F Evap Temperature	BTU/H	2730	4980	(2) 2500	6830	7950
Electric Supply	(V/Ph/Hz)	220/1/60	220/1/60	(2) 220/1/60	220/1/60	220/1/60
Power Consumption	(W/A)	700/3.9	1200/6.9	(2) 650/3.5	1700/9.5	2300/12.9
Defrost	Mode/Type	Automatic	Automatic	Automatic	Automatic	Automatic
Climatic Class	°F/%RH	75°F-55%RH	75°F-55%RH	75°F-55%RH	75°F-55%RH	75°F-55%RH
Refrigerant Gas	Type	R452a	R452a	R452a	R452a	R452a
Pipe Size (Suction-Liquid)	(INCHES)	15/32" - 15/64"	35/64" - 5/16"	(2) 15/32" - 15/64"	5/8" - 5/16"	45/64" - 25/64"
Net Weights	Lb	309	573	661	750	904
Crated Weights	Lb	369	633	721	810	964

*DIMENSIONS WITH POLISHED S/S SIDES

*Oscartek® reserves the right to change, modify, discontinue, or change any features, sizes, or capacity on any model without prior notice.

OSCARTEK®
512 South Airport Blvd., South San Francisco, CA 94080
Tel: 855.885.2400 | 650.342.2400 | Fax: 650.342.7400
sales@oscartek.com | www.oscartek.com



PROVINO II

Display for fine dining



Bring your cellar to your customer. This graceful display is a magnet in fine restaurants and can accommodate any foods besides wine, thanks to a split refrigeration system that controls each display chamber. Not only a proven profit center, it is the ultimate shopping experience. LED lighting as standard.



OSCARTEK®

Discover the Art of Display...

512 South Airport Blvd., South San Francisco, CA 94080
Tel: 855.885.2400 | 650.342.2400 | Fax: 650.342.7400
sales@oscartek.com | www.oscartek.com



ProVino II Image Gallery



512 South Airport Blvd., South San Francisco, CA 94080
Tel: 855.885.2400 | 650.342.2400 | Fax: 650.342.7400
sales@oscartek.com | www.oscartek.com



Provino II CC 1390

Visit our website for optional RAL colors and Materials finishes.

[RAL Colors Website](#)

[Materials Brochure PDF](#)

Project Name: _____

Item #: _____ Quantity: _____

PROVINO II CHEESE & CHARCUTERIE

MODELS: PROVINO II CC700, CC800, CC1390, CC1390-2T, CC2075

STANDARD FEATURES

- Glass sides and back
- Dual Medium Temperature Version with intermediate double glass divider
- Triple pane glass premium door
- Steel load bearing structure
- 3000°K LED lighting with dimmer switch
- Touch Control
- Ventilated cooling
- interior vertical shelf support in stainless steel
- adjustable feet
- standard steel 304A
- stainless steel interior and exterior
- Hanging rods and glass shelf adjustable in height on racks
- programmed automatic electric defrost
- Approvals: cETLus, ETL sanitation, certified CE
- Self-contained
- Condensate evaporator pan

OPTIONS



- RAL Color Option powder coated door handles exterior and interior over stainless
- Front wood laminate door and handles
- interior shelf trim
- Front wood laminate storage doors finish on base
- top door and interior shelf trim
- Top door
- door locks
- Remote application
- Top mounted condensing unit
- water cooled
- central refrigeration rack
- 60 Hz components UL
- 6mm thick stone back panel behind shelf
- Narrow Depth
- Front breathing available for 1400 - 2800 models
- Hanging poles

*Oscartek® reserves the right to change, modify, discontinue, or change any features, sizes, or capacity on any model without prior notice.

MODELS: PROVINO II CC700, CC800, CC1390, CC1390-2T, CC2075

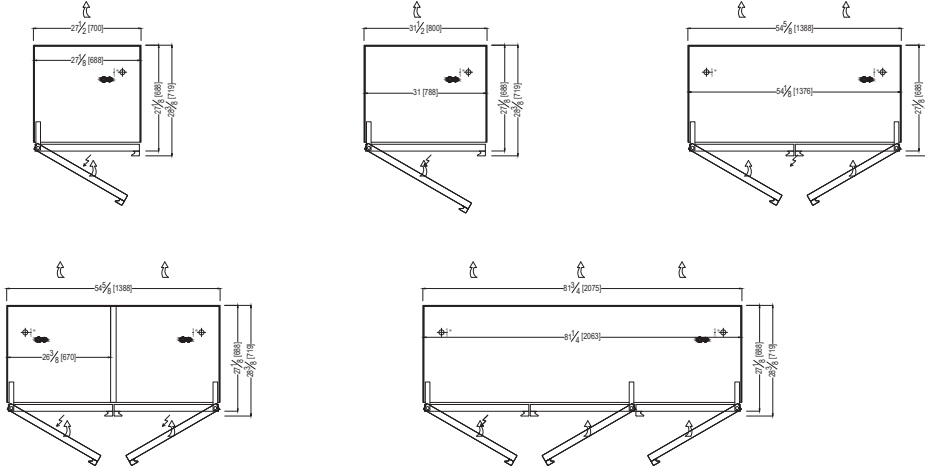
**PROVINO II
PLAN VIEWS**



ELECTRICAL LEGEND	
	REFRIGERATION LINES
	DRAIN
	POWER

**PROVINO II
REAR ELEVATIONS (OPERATOR SIDE)**

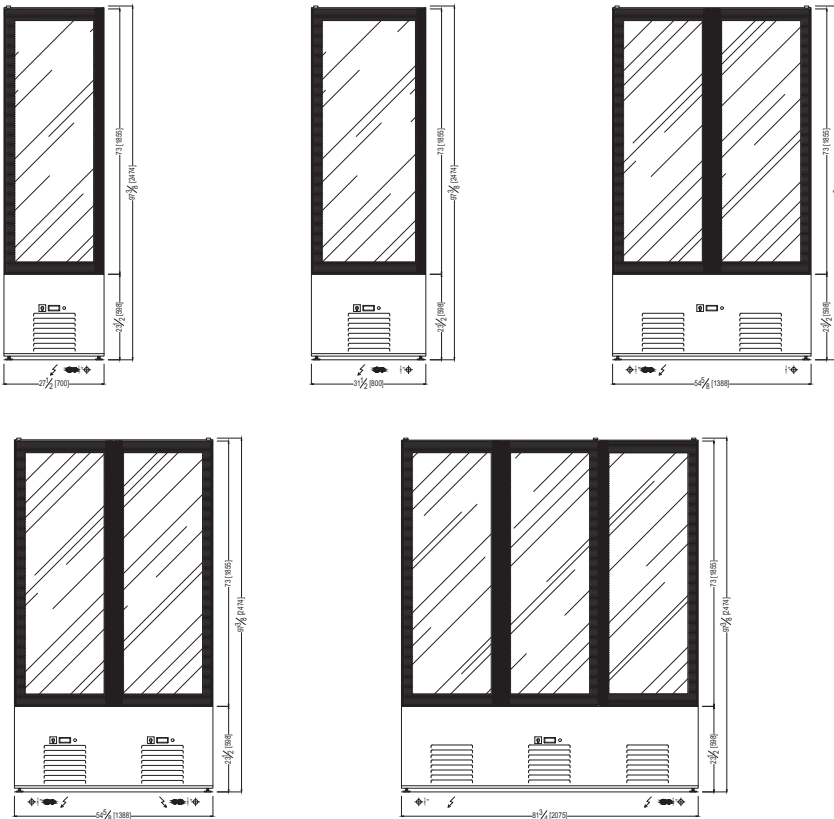

*Oscartek® reserves the right to change, modify, discontinue, or change any features, sizes, or capacity on any model without prior notice.

OSCARTEK®
512 South Airport Blvd., South San Francisco, CA 94080
Tel: 855.885.2400 | 650.342.2400 | Fax: 650.342.7400
sales@oscartek.com | www.oscartek.com



MODELS: PROVINO II CC700, CC800, CC1390, CC1390-2T, CC2075

**PROVINO II
SECTION VIEWS**

**STANDARD:
SELF-CONTAINED
W/ HANGING RODS**

**STANDARD:
REMOTE WITH
VERTICAL SHELVES**

**OPTIONAL:
HANGING POLES**

**OPTIONAL:
TOP MOUNTED
CONDENSING UNIT**

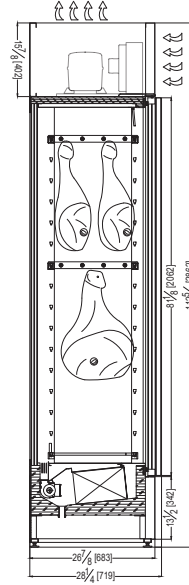
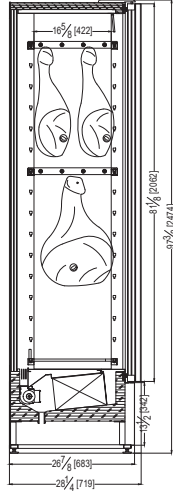
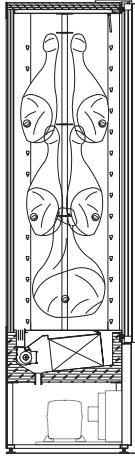
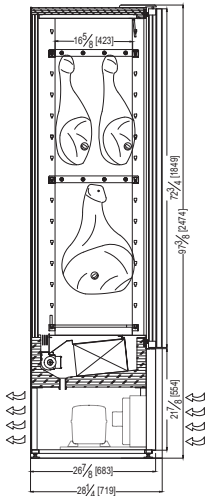

**PROVINO II - WITH FRONT AND REAR DOORS
SECTION VIEWS**

**STANDARD:
SELF-CONTAINED**

**STANDARD:
REMOTE**

**OPTIONAL:
TOP MOUNTED
CONDENSING UNIT**

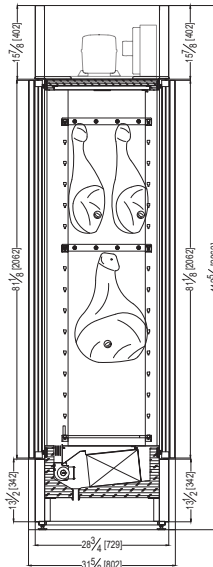
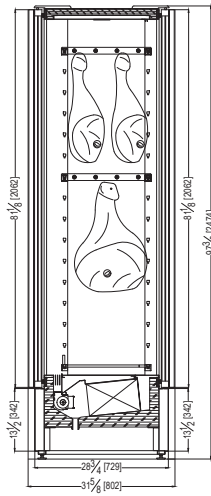
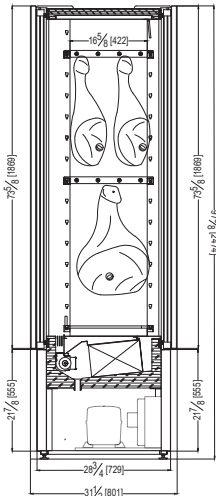

*Oscartek® reserves the right to change, modify, discontinue, or change any features, sizes, or capacity on any model without prior notice.

OSCARTEK®
512 South Airport Blvd., South San Francisco, CA 94080
Tel: 855.885.2400 | 650.342.2400 | Fax: 650.342.7400
sales@oscartek.com | www.oscartek.com





Project Name: _____

Item #: _____ Quantity: _____

MODELS: PROVINO II CC700, CC800, CC1390, CC1390-2T, CC2075

PROVINO II CHEESE & CHARCUTERIE - SELF CONTAINED						
TECHNICAL FEATURES		MODELS				
Model Name (Model Code)		PROVINO II CC700 (PROVINO1P)	PROVINO II CC800 (PROVINO1P)	PROVINO II CC1390 (PROVINO2P)	PROVINO II CC1390-2T (PROVINO1P)X2	PROVINO II CC2075 (PROVINO3P)
External Dimensions (L-D-H)	Inches	*27 1/2" - 28 1/4" - 97 3/8"	*31 1/2" - 28 1/4" - 97 3/8"	*54 5/8" - 28 1/4" - 97 3/8"	*82 5/8" - 28 1/4" - 97 3/8"	*81 3/4" - 28 1/4" - 97 3/8"
Inches-MM	MM	*700 - 719 - 2474	*800 - 719 - 2474	*1388 - 719 - 2474	*1388 - 719 - 2474	*2075 - 719 - 2474
Crated Dimensions (L-D-H)	Inches	35" - 35" - 108"	38 3/5" - 35" - 108"	61 4/5" - 35" - 108"	62 4/5" - 35" - 108"	88 4/5" - 35" - 108"
Inches-MM	MM	880 - 870 - 2744	980 - 870 - 2745	1570 - 870 - 2746	1570 - 870 - 2746	2255 - 870 - 2748
Refrigeration	Type	Fan - Ventilated	Fan - Ventilated	Fan - Ventilated	Fan - Ventilated	Fan - Ventilated
Refrigeration Display Area	Type	Deck	Deck	Deck	Deck	Deck
Number of Glass Doors	#	1	2	2	3	4
Operating Temperature	°F	32°F to 41°F	32°F to 41°F	32°F to 41°F	32°F to 41°F	32°F to 41°F
Condensing Units	#	1	2	2	3	4
Compressor	Nr./Type	1 / Hermetic	1 / Hermetic	1 / Hermetic	1 / Hermetic	2 / Hermetic
Electric Supply	(V/Ph/Hz)	220/1/60	220/1/60	220/1/60	(2) 220/1/60	220/1/60
Power Consumption	(W/A)	700/3.8	700/3.8	1360/7.6	(2) 680/3.6	1970/11.1
Defrost	Mode/Type	Automatic	Automatic	Automatic	Automatic	Automatic
Climatic Class	°F/%RH	75°F-55%RH	75°F-55%RH	75°F-55%RH	75°F-55%RH	75°F-55%RH
Refrigerant Gas	Type	R290	R290	R290	R290	R291
Net Weights	Lb	551	617	816	838	1080
Crated Weights	Lb	600	680	880	920	1160

*DIMENSIONS WITH POLISHED S/S SIDES

PROVINO II CHEESE & CHARCUTERIE - REMOTE						
TECHNICAL FEATURES		MODELS				
Model Name (Model Code)		PROVINO II CC700 (PROVINO1P)	PROVINO II CC800 (PROVINO1P)	PROVINO II CC1390 (PROVINO2P)	PROVINO II CC1390-2T (PROVINO1P)X2	PROVINO II CC2075 (PROVINO3P)
External Dimensions (L-D-H)	Inches	*27 1/2" - 28 1/4" - 97 3/8"	*31 1/2" - 28 1/4" - 97 3/8"	*54 5/8" - 28 1/4" - 97 3/8"	*82 5/8" - 28 1/4" - 97 3/8"	*81 3/4" - 28 1/4" - 97 3/8"
Inches-MM	MM	*700 - 719 - 2474	*800 - 719 - 2474	*1388 - 719 - 2474	*1388 - 719 - 2474	*2075 - 719 - 2474
Crated Dimensions (L-D-H)	Inches	35" - 35" - 108"	38 3/5" - 35" - 108"	61 4/5" - 35" - 108"	62 4/5" - 35" - 108"	88 4/5" - 35" - 108"
Inches-MM	MM	880 - 870 - 2744	980 - 870 - 2745	1570 - 870 - 2746	1570 - 870 - 2746	2255 - 870 - 2748
Refrigeration	Type	Fan - Ventilated	Fan - Ventilated	Fan - Ventilated	Fan - Ventilated	Fan - Ventilated
Refrigeration Display Area	Type	Deck	Deck	Deck	Deck	Deck
Number of Glass Doors	#	1	2	2	3	4
Operating Temperature	°F	45°F to 58°F	45°F to 58°F	45°F to 58°F	45°F to 58°F	45°F to 58°F
Condensing Units	#	1	2	2	3	4
Compressor	Nr./Type	1 / Hermetic	1 / Hermetic	1 / Hermetic	1 / Hermetic	2 / Hermetic
BTU'S @ +14°F Evap Temperature	BTU/H	2900	3240	4950	(2) 2400	7200
Electric Supply	(V/Ph/Hz)	220/1/60	220/1/60	220/1/60	(2) 220/1/60	220/1/60
Power Consumption	(W/A)	700/3.8	700/3.8	1360/7.6	(2) 680/3.6	1970/11.1
Defrost	Mode/Type	Automatic	Automatic	Automatic	Automatic	Automatic
Climatic Class	°F/%RH	75°F-55%RH	75°F-55%RH	75°F-55%RH	75°F-55%RH	75°F-55%RH
Refrigerant Gas	Type	R452a	R452a	R452a	R452a	R452a
Pipe Size (Suction-Liquid)	(INCHES)	15/32"- 15/64"	15/32"- 15/64"	35/64"- 5/16"	(2) 15/32"- 15/64"	5/8" - 5/16"
Net Weights	Lb	551	617	816	838	1080
Crated Weights	Lb	600	680	880	920	1160

*DIMENSIONS WITH POLISHED S/S SIDES

*Oscartek® reserves the right to change, modify, discontinue, or change any features, sizes, or capacity on any model without prior notice.

OSCARTEK®
 512 South Airport Blvd., South San Francisco, CA 94080
 Tel: 855.885.2400 | 650.342.2400 | Fax: 650.342.7400
 sales@oscartek.com | www.oscartek.com



PROVINO II DELI PASTRY

MODELS: PROVINO II DP700, DP800, DP1390, DP1390-2T, DP2075

STANDARD FEATURES

- Glass sides and back
- Dual Medium Temperature Version with intermediate double glass divider
- Triple pane glass premium door
- Steel load bearing structure
- 3000°K LED lighting with dimmer switch
- Touch Control
- Ventilated cooling
- interior vertical shelf support in stainless steel
- adjustable feet
- standard steel 304A
- stainless steel interior and exterior
- Glass shelves adjustable in height on racks (7 shelves included per door)
- programmed automatic electric defrost
- Approvals: cETLus, ETL sanitation, certified CE
- Self-contained
- Condensate evaporator pan

OPTIONS

- RAL Color Option powder coated door handles exterior and interior over stainless
- Front wood laminate door and handles
- interior shelf trim
- Front wood laminate storage doors finish on base
- top door and interior shelf trim
- Top door
- door locks
- Remote application
- Top mounted condensing unit
- water cooled
- central refrigeration rack
- 60 Hz components UL
- 6mm thick stone back panel behind shelf
- Narrow Depth
- front breathing available for 1400 - 2800 models



Provino II Deli/Pastry

Visit our website for optional RAL colors and Materials finishes.

[RAL Colors Website](#)

[Materials Brochure PDF](#)

*Oscartek® reserves the right to change, modify, discontinue, or change any features, sizes, or capacity on any model without prior notice.



OSCARTEK®
512 South Airport Blvd., South San Francisco, CA 94080
Tel: 855.885.2400 | 650.342.2400 | Fax: 650.342.7400
sales@oscartek.com | www.oscartek.com

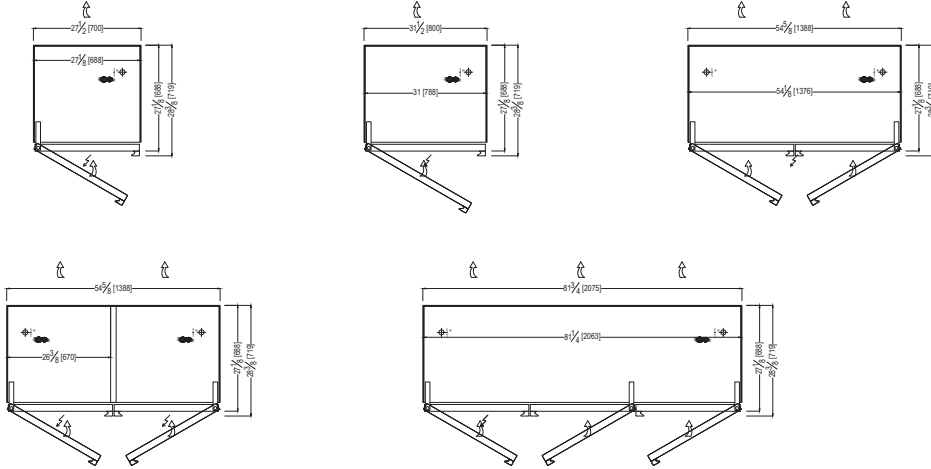

MODELS: PROVINO II DP700, DP800, DP1390, DP1390-2T, DP2075

**PROVINO II
PLAN VIEWS**



ELECTRICAL LEGEND	
	REFRIGERATION LINES
	DRAIN
	POWER

**PROVINO II
REAR ELEVATIONS (OPERATOR SIDE)**

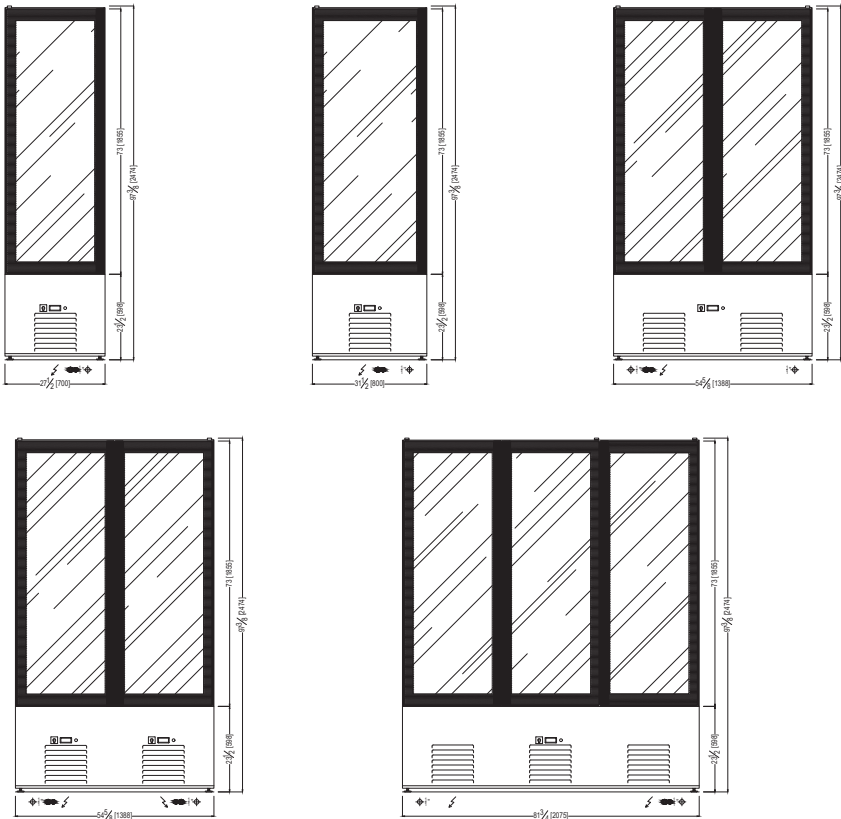

*Oscartek® reserves the right to change, modify, discontinue, or change any features, sizes, or capacity on any model without prior notice.

OSCARTEK®
512 South Airport Blvd., South San Francisco, CA 94080
Tel: 855.885.2400 | 650.342.2400 | Fax: 650.342.7400
sales@oscartek.com | www.oscartek.com



MODELS: PROVINO II DP700, DP800, DP1390, DP1390-2T, DP2075

**PROVINO II
SECTION VIEWS**

**STANDARD:
SELF-CONTAINED**

**STANDARD:
REMOTE WITH
VERTICAL SHELVES**

**OPTIONAL:
TOP MOUNTED
CONDENSING UNIT**

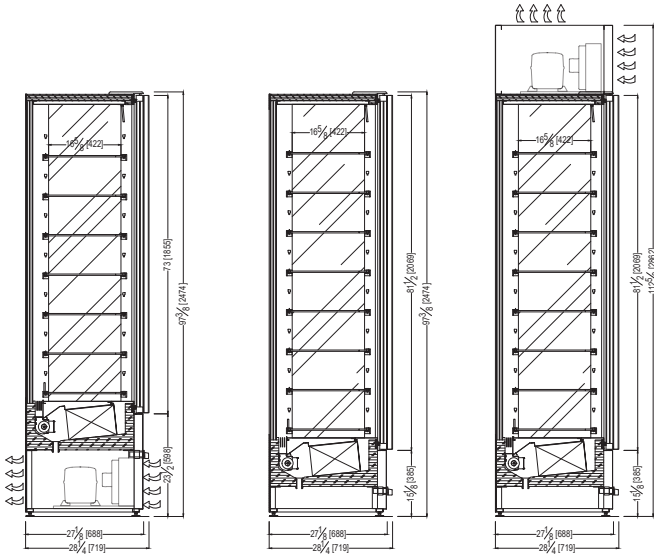

**PROVINO II - WITH FRONT AND REAR DOORS
SECTION VIEWS**

**OPTIONAL:
TOP MOUNTED
CONDENSING UNIT**

**STANDARD:
REMOTE**

**STANDARD:
SELF-CONTAINED**

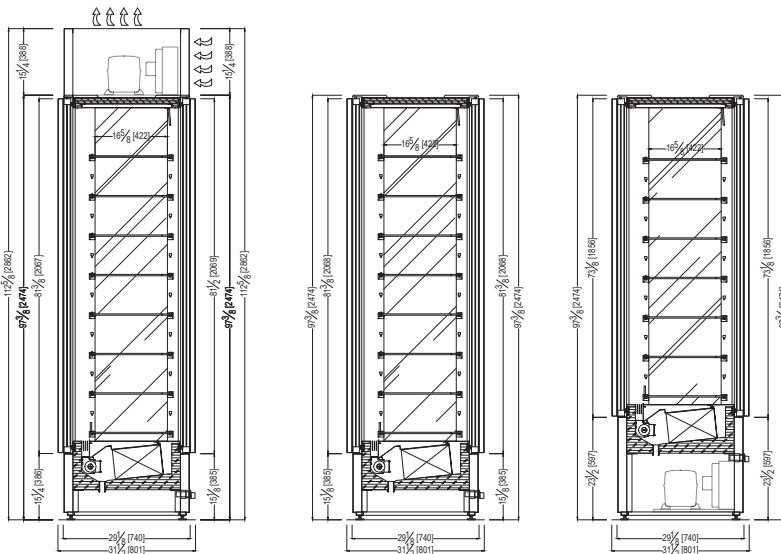

*Oscartek® reserves the right to change, modify, discontinue, or change any features, sizes, or capacity on any model without prior notice.



Discover the Art of Display...

Project Name: _____

Item #: _____ Quantity: _____

MODELS: PROVINO II DP700, DP800, DP1390, DP1390-2T, DP2075

PROVINO II DELI PASTRY - SELF CONTAINED						
TECHNICAL FEATURES		MODELS				
Model Name (Model Code)		PROVINO II DP700 (PROVINO1P)	PROVINO II DP800 (PROVINO1P)	PROVINO II DP1390 (PROVINO2P)	PROVINO II DP1390-2T (PROVINO1P)X2	PROVINO II DP2075 (PROVINO3P)
External Dimensions (L-D-H)	Inches	*27 1/2" - 28 1/4" - 97 3/8"	*31 1/2" - 28 1/4" - 97 3/8"	*54 5/8" - 28 1/4" - 97 3/8"	*82 5/8" - 28 1/4" - 97 3/8"	*81 3/4" - 28 1/4" - 97 3/8"
Inches-MM	MM	*700 - 719 - 2474	*800 - 719 - 2474	*1388 - 719 - 2474	*1388 - 719 - 2474	*2075 - 719 - 2474
Crated Dimensions (L-D-H)	Inches	35" - 35" - 108"	38 3/5" - 35" - 108"	61 4/5" - 35" - 108"	62 4/5" - 35" - 108"	88 4/5" - 35" - 108"
Inches-MM	MM	880 - 870 - 2744	980 - 870 - 2745	1570 - 870 - 2746	1570 - 870 - 2746	2255 - 870 - 2748
Refrigeration	Type	Fan - Ventilated	Fan - Ventilated	Fan - Ventilated	Fan - Ventilated	Fan - Ventilated
Refrigeration Display Area	Type	Deck	Deck	Deck	Deck	Deck
Number of Glass Doors	#	1	2	2	3	4
Operating Temperature	°F	32°F to 41°F	32°F to 41°F	32°F to 41°F	32°F to 41°F	32°F to 41°F
Condensing Units	#	1	2	2	3	4
Compressor	Nr./Type	1 / Hermetic	1 / Hermetic	1 / Hermetic	1 / Hermetic	2 / Hermetic
Electric Supply	(V/Ph/Hz)	220/1/60	220/1/60	220/1/60	(2) 220/1/60	220/1/60
Power Consumption	(W/A)	700/3.8	700/3.8	1360/7.6	(2) 680/3.6	1970/11.1
Defrost	Mode/Type	Automatic	Automatic	Automatic	Automatic	Automatic
Climatic Class	°F/%RH	75°F-55%RH	75°F-55%RH	75°F-55%RH	75°F-55%RH	75°F-55%RH
Refrigerant Gas	Type	R290	R290	R290	R290	R291
Net Weights	Lb	551	617	816	838	1080
Crated Weights	Lb	600	680	880	920	1160

*DIMENSIONS WITH POLISHED S/S SIDES

PROVINO II DELI PASTRY - REMOTE						
TECHNICAL FEATURES		MODELS				
Model Name (Model Code)		PROVINO II DP700 (PROVINO1P)	PROVINO II DP800 (PROVINO1P)	PROVINO II DP1390 (PROVINO2P)	PROVINO II DP1390-2T (PROVINO1P)X2	PROVINO II DP2075 (PROVINO3P)
External Dimensions (L-D-H)	Inches	*27 1/2" - 28 1/4" - 97 3/8"	*31 1/2" - 28 1/4" - 97 3/8"	*54 5/8" - 28 1/4" - 97 3/8"	*82 5/8" - 28 1/4" - 97 3/8"	*81 3/4" - 28 1/4" - 97 3/8"
Inches-MM	MM	*700 - 719 - 2474	*800 - 719 - 2474	*1388 - 719 - 2474	*1388 - 719 - 2474	*2075 - 719 - 2474
Crated Dimensions (L-D-H)	Inches	35" - 35" - 108"	38 3/5" - 35" - 108"	61 4/5" - 35" - 108"	62 4/5" - 35" - 108"	88 4/5" - 35" - 108"
Inches-MM	MM	880 - 870 - 2744	980 - 870 - 2745	1570 - 870 - 2746	1570 - 870 - 2746	2255 - 870 - 2748
Refrigeration	Type	Fan - Ventilated	Fan - Ventilated	Fan - Ventilated	Fan - Ventilated	Fan - Ventilated
Refrigeration Display Area	Type	Deck	Deck	Deck	Deck	Deck
Number of Glass Doors	#	1	2	2	3	4
Operating Temperature	°F	45°F to 58°F	45°F to 58°F	45°F to 58°F	45°F to 58°F	45°F to 58°F
Condensing Units	#	1	2	2	3	4
Compressor	Nr./Type	1 / Hermetic	1 / Hermetic	1 / Hermetic	1 / Hermetic	2 / Hermetic
BTU'S @ +14°F Evap Temperature		2900	3240	4950	(2) 2400	7200
Electric Supply	(V/Ph/Hz)	220/1/60	220/1/60	220/1/60	(2) 220/1/60	220/1/60
Power Consumption	(W/A)	700/3.8	700/3.8	1360/7.6	(2) 680/3.6	1970/11.1
Defrost	Mode/Type	Automatic	Automatic	Automatic	Automatic	Automatic
Climatic Class	°F/%RH	75°F-55%RH	75°F-55%RH	75°F-55%RH	75°F-55%RH	75°F-55%RH
Refrigerant Gas	Type	R452a	R452a	R452a	R452a	R452a
Pipe Size (Suction-Liquid)	(INCHES)	15/32"- 15/64"	15/32"- 15/64"	35/64"- 5/16"	(2) 15/32"- 15/64"	5/8" - 5/16"
Net Weights	Lb	551	617	816	838	1080
Crated Weights	Lb	600	680	880	920	1160

*DIMENSIONS WITH POLISHED S/S SIDES

*Oscartek® reserves the right to change, modify, discontinue, or change any features, sizes, or capacity on any model without prior notice.

OSCARTEK®
 512 South Airport Blvd., South San Francisco, CA 94080
 Tel: 855.885.2400 | 650.342.2400 | Fax: 650.342.7400
 sales@oscartek.com | www.oscartek.com



PROVINO II FROZEN

MODELS: PROVINO II G700, G800, G1390

STANDARD FEATURES

- Glass sides and back
- Triple pane glass premium door
- Steel load bearing structure
- 3000°K LED lighting with dimmer switch
- Touch Control
- Ventilated cooling
- interior vertical shelf support in stainless steel
- adjustable feet
- standard steel 304A
- stainless steel interior and exterior
- Glass shelves adjustable in height on racks (7 shelves included per door)
- programmed automatic electric defrost
- Approvals: cETLus, ETL sanitation, certified CE
- Remote condensing unit
- Condensate evaporator pan

OPTIONS

- RAL Color Option powder coated door handles exterior and interior over stainless
- Front wood laminate door and handles
- interior shelf trim
- Front wood laminate storage doors finish on base
- top door and interior shelf trim
- Top door
- door locks
- water cooled
- central refrigeration rack
- 60 Hz components UL
- Narrow Depth



Provino II Frozen

Visit our website for optional RAL colors and Materials finishes.

[RAL Colors Website](#)

[Materials Brochure PDF](#)

*Oscartek® reserves the right to change, modify, discontinue, or change any features, sizes, or capacity on any model without prior notice.

OSCARTEK®
512 South Airport Blvd., South San Francisco, CA 94080
Tel: 855.885.2400 | 650.342.2400 | Fax: 650.342.7400
sales@oscartek.com | www.oscartek.com





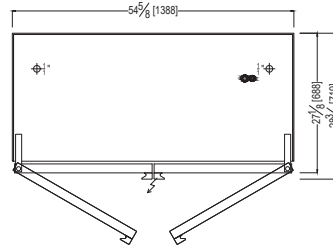
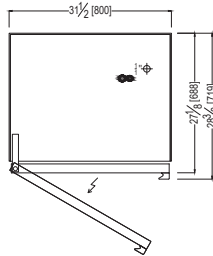
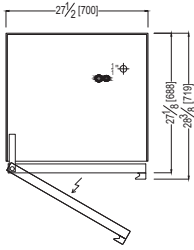

MODELS: PROVINO II G700, G800, G1300

**PROVINO II
PLAN VIEWS**

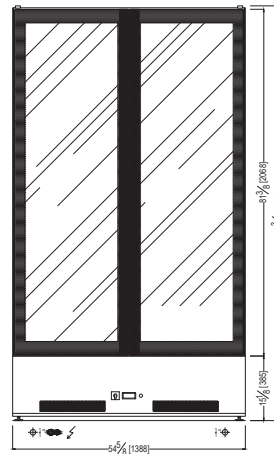
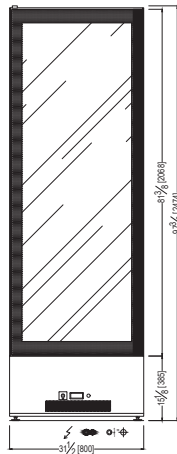
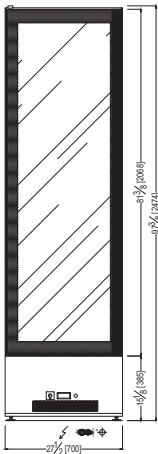

**PROVINO II
REAR ELEVATIONS (OPERATOR SIDE)**



ELECTRICAL LEGEND	
	REFRIGERATION LINES
	DRAIN
	POWER

**PROVINO II STANDARD - REMOTE WITH SHELVES
SECTION VIEW**

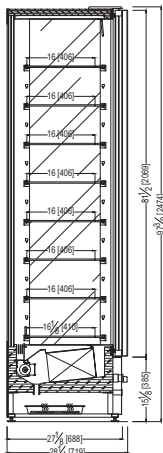

*Oscartek® reserves the right to change, modify, discontinue, or change any features, sizes, or capacity on any model without prior notice.

OSCARTEK®
512 South Airport Blvd., South San Francisco, CA 94080
Tel: 855.885.2400 | 650.342.2400 | Fax: 650.342.7400
sales@oscartek.com | www.oscartek.com





Discover the Art of Display...

Project Name: _____

Item #: _____ Quantity: _____

MODELS: PROVINO II G700, G800, G1390

PROVINO II FROZEN - REMOTE				
TECHNICAL FEATURES		MODELS		
Model Name (Model Code)		PROVINO II G700 (METROGEL12)	PROVINO II G800 (METROGEL12)	PROVINO II G1390 (METROGEL18)
External Dimensions (L-D-H) Inches-MM	Inches MM	*27 1/2" - 28 1/4" - 97 3/8" *700 - 719 - 2474	*31 1/2" - 28 1/4" - 97 3/8" *800 - 719 - 2474	*54 5/8" - 28 1/4" - 97 3/8" *1388 - 719 - 2474
Crated Dimensions (L-D-H) Inches-MM	Inches MM	35" - 35" - 108" 880 - 870 - 2744	38 3/5" - 35" - 108" 980 - 870 - 2745	61 4/5" - 35" - 108" 1570 - 870 - 2746
Refrigeration	Type	Fan - Ventilated	Fan - Ventilated	Fan - Ventilated
Refrigeration Display Area	Type	Deck	Deck	Deck
Number of Glass Doors	#	1	2	2
Operating Temperature	°F	-5°F to 5°F	-5°F to 5°F	-5°F to 5°F
Condensing Units	#	1	2	2
Compressor	Nr./Type	1 / Hermetic	1 / Hermetic	1 / Hermetic
BTU'S @ -31°F Evap Temperature	BTU/H	3750	4100	6140
Electric Supply	(V/Ph/Hz)	220/3/60	220/3/60	220/3/60
Power Consumption	(W/A)	2300/11.5	2300/11.5	4600/16.5
Defrost	Mode/Type	Automatic	Automatic	Automatic
Climatic Class	°F/%RH	75°F-55%RH	75°F-55%RH	75°F-55%RH
Refrigerant Gas	Type	R452a	R452a	R452a
Pipe Size (Suction-Liquid)	(INCHES)	45/64"- 25/64"	45/64"- 25/64"	55/64"- 25/64"
Net Weights	Lb	551	617	816
Crated Weights	Lb	600	680	880

*DIMENSIONS WITH POLISHED S/S SIDES

*Oscartek® reserves the right to change, modify, discontinue, or change any features, sizes, or capacity on any model without prior notice.

OSCARTEK®
512 South Airport Blvd., South San Francisco, CA 94080
Tel: 855.885.2400 | 650.342.2400 | Fax: 650.342.7400
sales@oscartek.com | www.oscartek.com





Provino II W 1390-2T with horizontal and slanted plexiglass wine racks and dual temperature control

Visit our website for optional RAL colors and Materials finishes.

[RAL Colors Website](#)

[Materials Brochure PDF](#)

Project Name: _____

Item #: _____ Quantity: _____

PROVINO II WINE

MODELS:

PROVINO II W700, W800, W1390, W1390-2T, W2075

STANDARD FEATURES

- Glass sides and back
- Dual Medium Temperature Version with intermediate double glass divider
- Triple pane glass premium door
- Steel load bearing structure
- 3000°K LED lighting with dimmer switch
- Touch Control
- Ventilated cooling
- interior vertical shelf support in stainless steel
- adjustable feet
- standard steel 304A
- stainless steel interior and exterior
- Glass shelves adjustable in height on racks (7 shelves included per door)
- programmed automatic electric defrost
- Approvals: cETLus, ETL sanitation, certified CE
- Self-contained
- Condensate evaporator pan

OPTIONS



- RAL Color Option powder coated door handles exterior and interior over stainless
- Front wood laminate door and handles
- interior shelf trim
- Front wood laminate storage doors finish on base top door and interior shelf trim
- Top door
- door locks
- Remote application
- Top mounted condensing unit
- water cooled
- central refrigeration rack
- 60 Hz components UL
- 6mm thick stone back panel behind shelf
- Narrow Depth
- front breathing available for 1400 - 2800 models

*Oscartek® reserves the right to change, modify, discontinue, or change any features, sizes, or capacity on any model without prior notice.

MODELS: PROVINO II W700, W800, W1390, W1390-2T, W2075

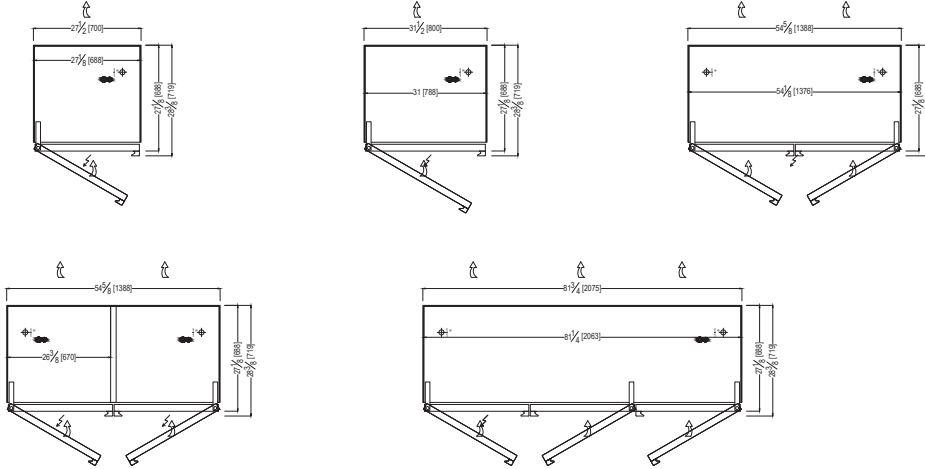
**PROVINO II
PLAN VIEWS**



ELECTRICAL LEGEND	
	REFRIGERATION LINES
	DRAIN
	POWER

**PROVINO II
REAR ELEVATIONS (OPERATOR SIDE)**

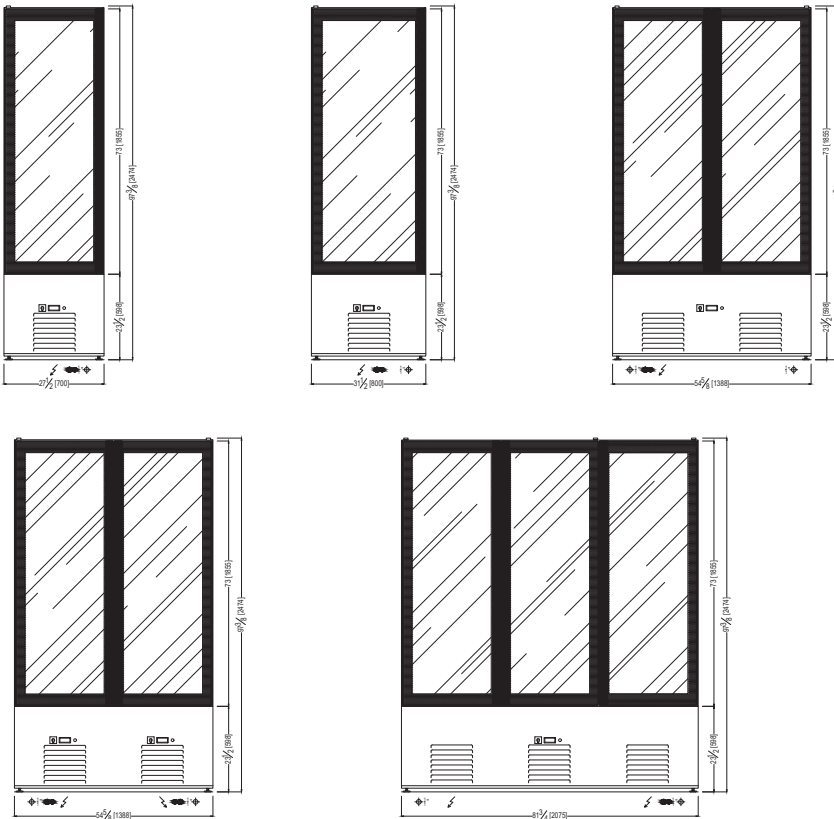

*Oscartek® reserves the right to change, modify, discontinue, or change any features, sizes, or capacity on any model without prior notice.

OSCARTEK®
512 South Airport Blvd., South San Francisco, CA 94080
Tel: 855.885.2400 | 650.342.2400 | Fax: 650.342.7400
sales@oscartek.com | www.oscartek.com



MODELS: PROVINO II W700, W800, W1390, W1390-2T, W2075

**PROVINO II
SECTION VIEWS**

**PROVINO II - WITH FRONT AND REAR DOORS
SECTION VIEWS**

**STANDARD:
SELF-CONTAINED**

**STANDARD:
REMOTE WITH
VERTICAL SHELVES**

**OPTIONAL:
TOP MOUNTED
CONDENSING UNIT**

**OPTIONAL:
TOP MOUNTED
CONDENSING UNIT**

**STANDARD:
REMOTE**

**STANDARD:
SELF-CONTAINED**

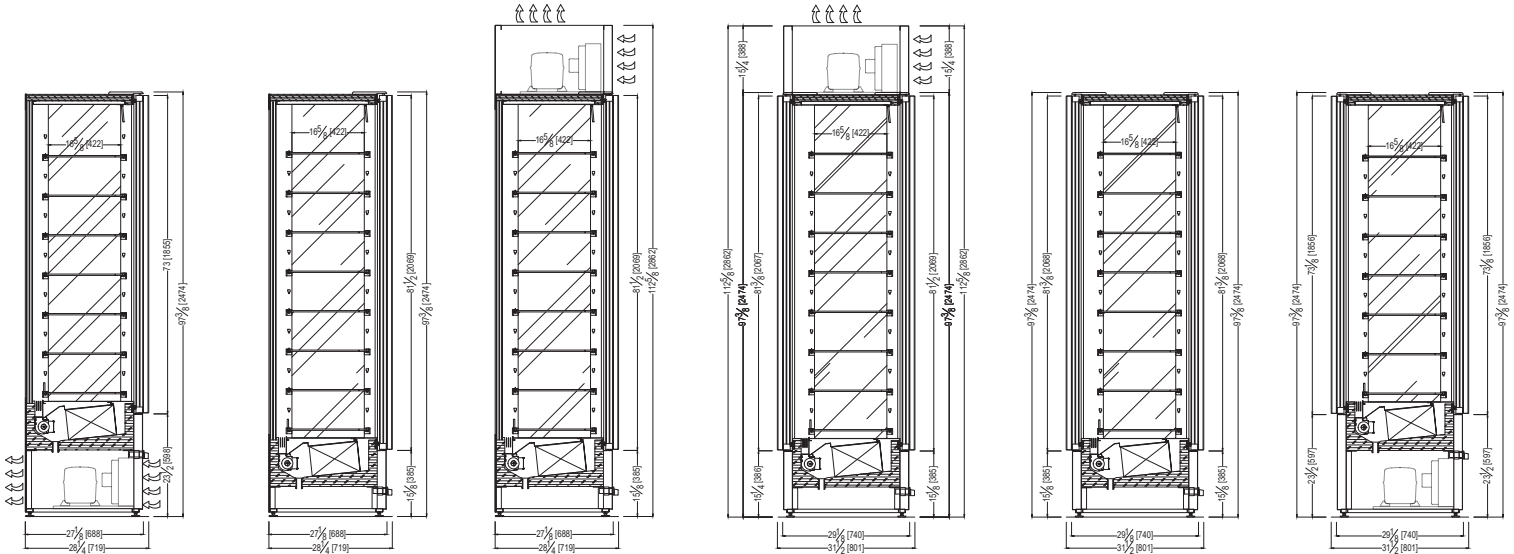

**PROVINO II- OPTIONAL WINE RACKS
SECTION VIEWS**

**OPTIONAL:
S/S ROUND
TUBULAR PYRAMID**

**OPTIONAL:
S/S ROUND
TUBULAR RACK**

**OPTIONAL:
SLANTED
PLEXIGLASS RACK**

**OPTIONAL:
HORIZONTAL
PLEXIGLASS RACK**

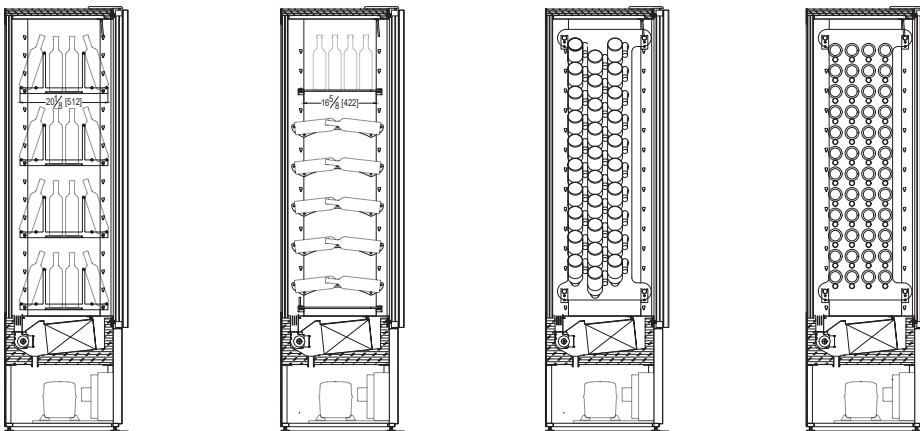

*Oscartek® reserves the right to change, modify, discontinue, or change any features, sizes, or capacity on any model without prior notice.



Discover the Art of Display...

Project Name: _____

Item #: _____ Quantity: _____

MODELS: PROVINO II W700, W800, W1390, W1390-2T, W2075

PROVINO II WINE - SELF CONTAINED						
TECHNICAL FEATURES		MODELS				
Model Name (Model ETL Code)		PROVINO II W700 (PROVINO1P)	PROVINO II W800 (PROVINO1P)	PROVINO II W1390 (PROVINO2P)	PROVINO II W1390-2T (PROVINO1P)X2	PROVINO II W2075 (PROVINO3P)
External Dimensions (L-D-H)	Inches	*27 1/2" - 28 1/4" - 97 3/8"	*31 1/2" - 28 1/4" - 97 3/8"	*54 5/8" - 28 1/4" - 97 3/8"	*82 5/8" - 28 1/4" - 97 3/8"	*81 3/4" - 28 1/4" - 97 3/8"
Inches-MM	MM	*700 - 719 - 2474	*800 - 719 - 2474	*1388 - 719 - 2474	*1388 - 719 - 2474	*2075 - 719 - 2474
Crated Dimensions (L-D-H)	Inches	35" - 35" - 108"	38 3/5" - 35" - 108"	61 4/5" - 35" - 108"	62 4/5" - 35" - 108"	88 4/5" - 35" - 108"
Inches-MM	MM	880 - 870 - 2744	980 - 870 - 2745	1570 - 870 - 2746	1570 - 870 - 2746	2255 - 870 - 2748
Refrigeration	Type	Fan - Ventilated	Fan - Ventilated	Fan - Ventilated	Fan - Ventilated	Fan - Ventilated
Refrigeration Display Area	Type	Deck	Deck	Deck	Deck	Deck
Number of Glass Doors	#	1	2	2	3	4
Wine Rack/ Shelf number	bottle orientation: #	Vertical Shelves: 7 Tubular Pyramid: 4 Tubular Rack: 6 Slanted Plexiglass Rack: 2 Horizontal Plexiglass Rack: 2	Vertical Shelves: 7 Tubular Pyramid: 4 Tubular Rack: 6 Slanted Plexiglass Rack: 2 Horizontal Plexiglass Rack: 3	Vertical Shelves: 14 Tubular Pyramid: 8 Tubular Rack: 12 Slanted Plexiglass Rack: 4 Horizontal Plexiglass Rack: 8	Vertical Shelves: 14 Tubular Pyramid: 8 Tubular Rack: 12 Slanted Plexiglass Rack: 4 Horizontal Plexiglass Rack: 9	Vertical Shelves: 21 Tubular Pyramid: 12 Tubular Rack: 18 Slanted Plexiglass Rack: 6 Horizontal Plexiglass Rack: 18
Bottle Capacity (STD size bottles)	#	Vertical Shelves:168 Tubular Pyramid: 32 Tubular Rack: 24 Slanted Plexiglass Rack: 60 Horizontal Plexiglass Rack: 96	Vertical Shelves: 224 Tubular Pyramid: 36 Tubular Rack: 36 Slanted Plexiglass Rack: 80 Horizontal Plexiglass Rack: 120	Vertical Shelves: 336 Tubular Pyramid: 64 Tubular Rack: 48 Slanted Plexiglass Rack: 120 Horizontal Plexiglass Rack: 192	Vertical Shelves: 168(2) Tubular Pyramid: 32(2) Tubular Rack: 24(2) Slanted Plexiglass Rack: 60(2) Horizontal Plexiglass Rack: 96(2)	Vertical Shelves: 504 Tubular Pyramid: 96 Tubular Rack: 72 Slanted Plexiglass Rack: 180 Horizontal Plexiglass Rack: 288
Operating Temperature	*F	45°F to 58°F	45°F to 58°F	45°F to 58°F	45°F to 58°F	45°F to 58°F
Condensing Units	#	1	2	2	3	4
Compressor	Nr./Type	1 / Hermetic	1 / Hermetic	1 / Hermetic	1 / Hermetic	2 / Hermetic
Electric Supply	(V/Ph/Hz)	220/1/60	220/1/60	220/1/60	(2) 220/1/60	220/1/60
Power Consumption	(W/A)	700/3.8	700/3.8	1360/7.6	(2) 680/3.6	1970/11.1
Defrost	Mode/Type	Automatic	Automatic	Automatic	Automatic	Automatic
Climatic Class	*F/%RH	75°F-55%RH	75°F-55%RH	75°F-55%RH	75°F-55%RH	75°F-55%RH
Refrigerant Gas	Type	R290	R290	R290	R290	R291
Net Weights	Lb	551	617	816	838	1080
Crated Weights	Lb	600	680	880	920	1160

*DIMENSIONS WITH POLISHED S/S SIDES

PROVINO II WINE - REMOTE						
TECHNICAL FEATURES		MODELS				
Model Name (Model ETL Code)		PROVINO II W700 (PROVINO1P)	PROVINO II W800 (PROVINO1P)	PROVINO II W1390 (PROVINO2P)	PROVINO II W1390-2T (PROVINO1P)X2	PROVINO II W2075 (PROVINO3P)
External Dimensions (L-D-H)	Inches	*27 1/2" - 28 1/4" - 97 3/8"	*31 1/2" - 28 1/4" - 97 3/8"	*54 5/8" - 28 1/4" - 97 3/8"	*82 5/8" - 28 1/4" - 97 3/8"	*81 3/4" - 28 1/4" - 97 3/8"
Inches-MM	MM	*700 - 719 - 2474	*800 - 719 - 2474	*1388 - 719 - 2474	*1388 - 719 - 2474	*2075 - 719 - 2474
Crated Dimensions (L-D-H)	Inches	35" - 35" - 108"	38 3/5" - 35" - 108"	61 4/5" - 35" - 108"	62 4/5" - 35" - 108"	88 4/5" - 35" - 108"
Inches-MM	MM	880 - 870 - 2744	980 - 870 - 2745	1570 - 870 - 2746	1570 - 870 - 2746	2255 - 870 - 2748
Refrigeration	Type	Fan - Ventilated	Fan - Ventilated	Fan - Ventilated	Fan - Ventilated	Fan - Ventilated
Refrigeration Display Area	Type	Deck	Deck	Deck	Deck	Deck
Number of Glass Doors	#	1	2	2	3	4
Wine Rack Shelves	bottle orientation: #	Vertical Shelves: 8 Tubular Pyramid: 4 Tubular Rack: 7 Slanted Plexiglass Rack: 2 Horizontal Plexiglass Rack: 2	Vertical Shelves: 8 Tubular Pyramid: 4 Tubular Rack: 7 Slanted Plexiglass Rack: 2 Horizontal Plexiglass Rack: 3	Vertical Shelves: 16 Tubular Pyramid: 8 Tubular Rack: 14 Slanted Plexiglass Rack: 4 Horizontal Plexiglass Rack: 8	Vertical Shelves: 16 Tubular Pyramid: 8 Tubular Rack: 14 Slanted Plexiglass Rack: 4 Horizontal Plexiglass Rack: 9	Vertical Shelves: 24 Tubular Pyramid: 12 Tubular Rack: 21 Slanted Plexiglass Rack: 6 Horizontal Plexiglass Rack: 18
Bottle Capacity (STD size)	#	Vertical Shelves:192 Tubular Pyramid: 32 Tubular Rack: 28 Slanted Plexiglass Rack: 72 Horizontal Plexiglass Rack: 112	Vertical Shelves: 256 Tubular Pyramid: 36 Tubular Rack: 42 Slanted Plexiglass Rack: 96 Horizontal Plexiglass Rack: 140	Vertical Shelves: 384 Tubular Pyramid: 64 Tubular Rack: 56 Slanted Plexiglass Rack: 144 Horizontal Plexiglass Rack: 224	Vertical Shelves: 192(2) Tubular Pyramid: 32(2) Tubular Rack: 28(2) Slanted Plexiglass Rack: 72(2) Horizontal Plexiglass Rack: 112(2)	Vertical Shelves: 576 Tubular Pyramid: 96 Tubular Rack: 84 Slanted Plexiglass Rack: 216 Horizontal Plexiglass Rack: 336
Operating Temperature	*F	45°F to 58°F	45°F to 58°F	45°F to 58°F	45°F to 58°F	45°F to 58°F
Condensing Units	#	1	2	2	3	4
Compressor	Nr./Type	1 / Hermetic	1 / Hermetic	1 / Hermetic	1 / Hermetic	2 / Hermetic
BTU'S @ +14°F Evap Temperature	BTU/H	2900	3240	4950	(2) 2400	7200
Electric Supply	(V/Ph/Hz)	220/1/60	220/1/60	220/1/60	(2) 220/1/60	220/1/60
Power Consumption	(W/A)	700/3.8	700/3.8	1360/7.6	(2) 680/3.6	1970/11.1
Defrost	Mode/Type	Automatic	Automatic	Automatic	Automatic	Automatic
Climatic Class	*F/%RH	75°F-55%RH	75°F-55%RH	75°F-55%RH	75°F-55%RH	75°F-55%RH
Refrigerant Gas	Type	R452a	R452a	R452a	R452a	R452a
Pipe Size (Suction-Liquid)	(INCHES)	15/32"- 15/64"	15/32"- 15/64"	35/64"- 5/16"	(2) 15/32"- 15/64"	5/8"- 5/16"
Net Weights	Lb	551	617	816	838	1080
Crated Weights	Lb	600	680	880	920	1160

*DIMENSIONS WITH POLISHED S/S SIDES

*Oscartek® reserves the right to change, modify, discontinue, or change any features, sizes, or capacity on any model without prior notice.

OSCARTEK®
512 South Airport Blvd., South San Francisco, CA 94080
Tel: 855.885.2400 | 650.342.2400 | Fax: 650.342.7400
sales@oscartek.com | www.oscartek.com

