

GALA

Self serve with style



A refrigerated niche into a wall of your shop for a variety of applications, from pastry to wine and champagne. A unique product in the market, highly customizable to match various finishes on the interior and exterior.



Discover the Art of Display...

512 South Airport Blvd., South San Francisco, CA 94080
Tel: 855.885.2400 | 650.342.2400 | Fax: 650.342.7400
sales@oscartek.com | www.oscartek.com





Gala Cheese & Charcuterie with custom finish

GALA CHEESE & CHARCUTERIE

MODELS: GALA CC700, CC1400, CC1400-2T, CC2100, CC2100-2T, CC2800

BACK WINDOW MODELS: GALA CC770BW, CC1370BW, CC1970BW

PASS THROUGH MODELS: GALA CC770PT, CC1370PT, CC1970PT

STANDARD FEATURES

- Solid Sides
- Dual Medium Temperature Version with intermediate double glass divider
- Triple pane glass premium door
- Steel load bearing structure
- 3000°K LED lighting with dimmer switch
- Touch Control
- Ventilated cooling
- interior vertical shelf support in stainless steel
- adjustable feet
- standard steel 304A
- stainless steel interior and exterior
- Stainless steel shelves adjustable in height and hanging racks
- programmed automatic electric defrost
- Approvals: cETLus, ETL sanitation, certified CE
- Remote condensing unit
- Condensate evaporator pan
- **Back Window & Pass Through:** glass shelving, glass sides
- **Back Window:** rear glass side
- **Pass Through:** rear glass door

Visit our website for optional RAL colors and Materials finishes.

[RAL Colors Website](#)

[Materials Brochure PDF](#)

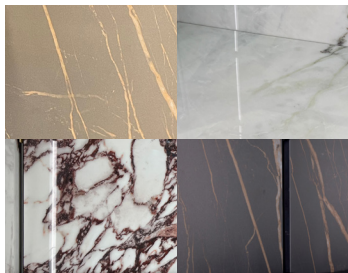



Examples of optional 6mm thick stone back panel behind shelf. For full selection see our Materials Brochure.

OPTIONS

- RAL Color Option powder coated door handles exterior and interior over stainless
- Front wood laminate door and handles
- interior shelf trim
- 6mm thick stone back panel behind shelf
- Glass Sides
- Wooden exterior
- top door and interior shelf trim
- Bottom mount condensing unit
- Top mounted condensing unit
- water cooled
- central refrigeration rack
- 60 Hz components UL
- 6mm thick stone back panel behind shelf
- Glass Sides
- Narrow Depth
- front breathing available for 1400L - 2800L models

*Oscartek® reserves the right to change, modify, discontinue, or change any features, sizes, or capacity on any model without prior notice.

MODELS: GALA CC700, CC1400, CC1400-2T, CC2100, CC2100-2T, CC2800
BACK WINDOW MODELS: GALA CC770BW, CC1370BW, CC1970BW
PASS THROUGH MODELS: GALA CC770PT, CC1370PT, CC1970PT

ELECTRICAL LEGEND	
	REFRIGERATION LINES
	DRAIN
	POWER

GALA CHEESE & CHARCUTERIE
PLAN VIEWS

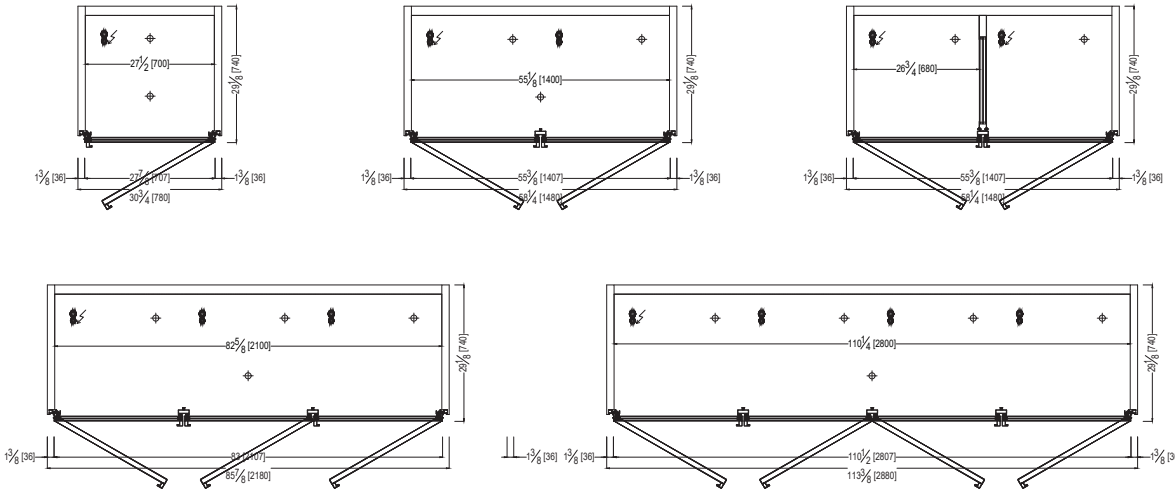

BACK WINDOW
PLAN VIEWS

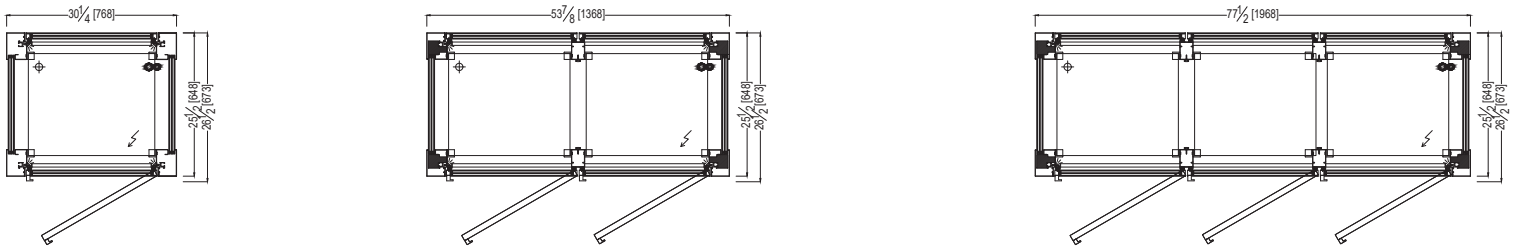

PASS THROUGH
PLAN VIEWS

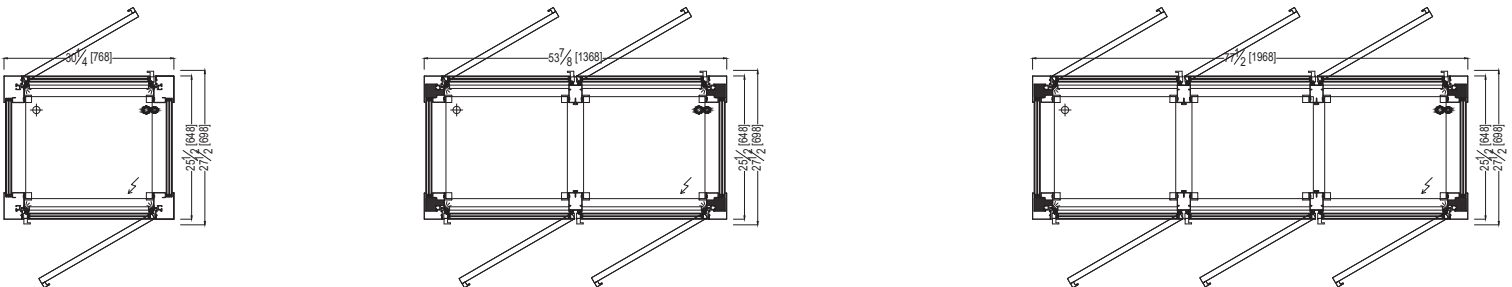

*Oscartek® reserves the right to change, modify, discontinue, or change any features, sizes, or capacity on any model without prior notice.

Discover the Art of Display...

MODELS: GALA CC700, CC1400, CC1400-2T, CC2100, CC2100-2T, CC2800

BACK WINDOW MODELS: GALA CC770BW, CC1370BW, CC1970BW

PASS THROUGH MODELS: GALA CC770PT, CC1370PT, CC1970PT

GALA CHEESE & CHARCUTERIE
FRONT ELEVATIONS

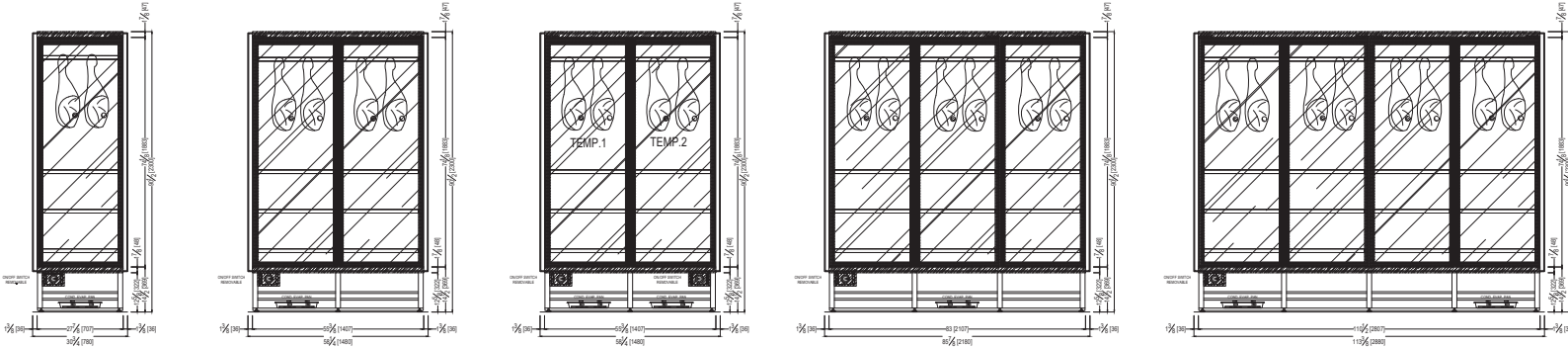

BACK WINDOW & PASS THROUGH
FRONT ELEVATIONS

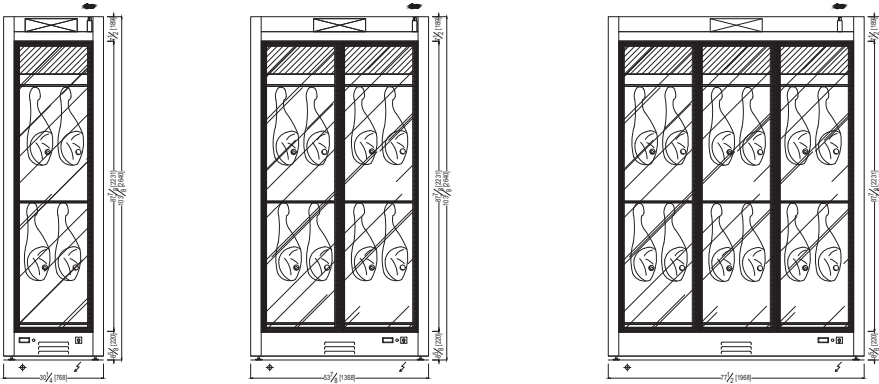

WALL CUT OUT ELEVATIONS

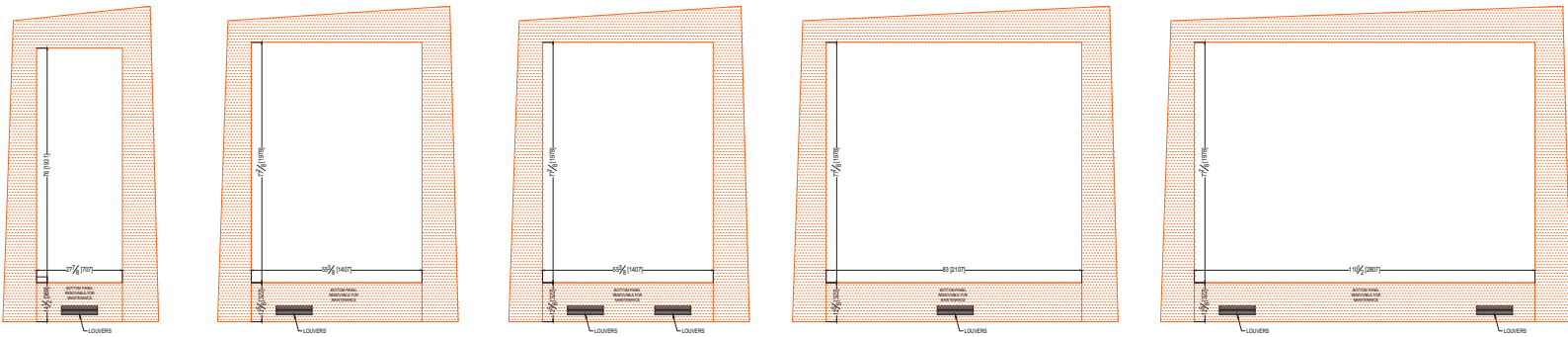

*Oscartek® reserves the right to change, modify, discontinue, or change any features, sizes, or capacity on any model without prior notice.

OSCARTEK®
512 South Airport Blvd., South San Francisco, CA 94080
Tel: 855.885.2400 | 650.342.2400 | Fax: 650.342.7400
sales@oscartek.com | www.oscartek.com



MODELS: GALA CC700, CC1400, CC1400-2T, CC2100, CC2100-2T, CC2800

BACK WINDOW MODELS: GALA CC770BW, CC1370BW, CC1970BW

PASS THROUGH MODELS: GALA CC770PT, CC1370PT, CC1970PT

GALA CHEESE & CHARCUTERIE - STANDARD DEPTH SECTION VIEWS

**STANDARD:
REMOTE**

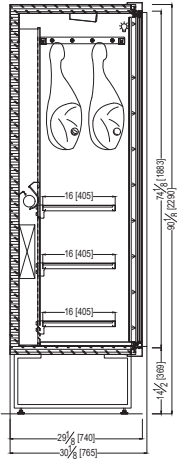

**STANDARD:
SELF-CONTAINED
WITH
GLASS SIDE**

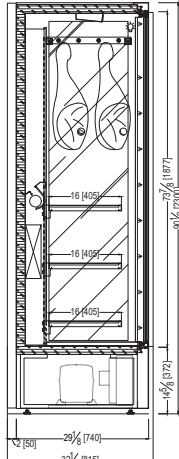

**OPTIONAL:
TOP MOUNTED
CONDENSING
UNIT**

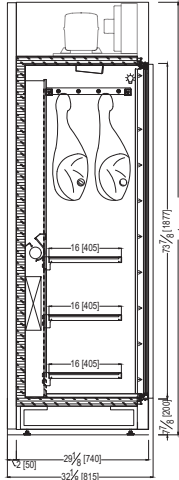

**OPTIONAL:
WOODEN
EXTERIOR
UNIT**

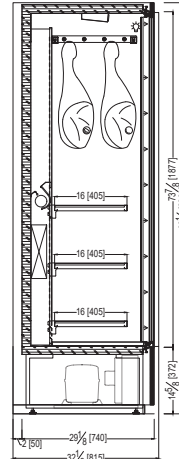

NARROW DEPTH SECTION VIEWS

**STANDARD:
REMOTE**

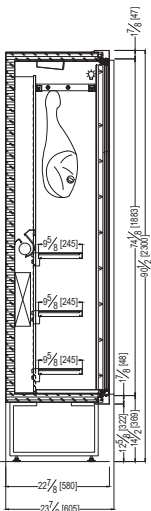

**STANDARD:
SELF-CONTAINED**

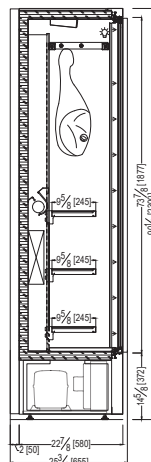

**OPTIONAL:
TOP MOUNTED
CONDENSING
UNIT**

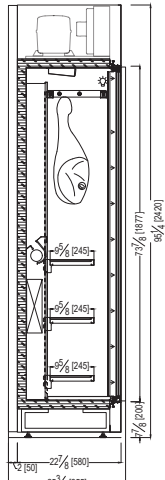

*Oscartek® reserves the right to change, modify, discontinue, or change any features, sizes, or capacity on any model without prior notice.

MODELS: GALA CC700, CC1400, CC1400-2T, CC2100, CC2100-2T, CC2800

BACK WINDOW MODELS: GALA CC770BW, CC1370BW, CC1970BW

PASS THROUGH MODELS: GALA CC770PT, CC1370PT, CC1970PT

GALA CHEESE & CHARCUTERIE - BACK WINDOW & PASS THROUGH
SECTION VIEWS

STANDARD:
BACK WINDOW REMOTE

OPTIONAL:
TOP MOUNTED
CONDENSING UNIT

STANDARD:
PASS THROUGH
REMOTE

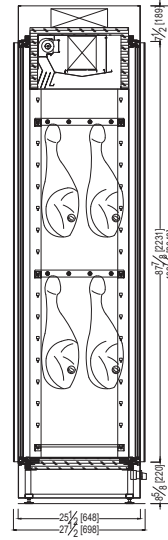
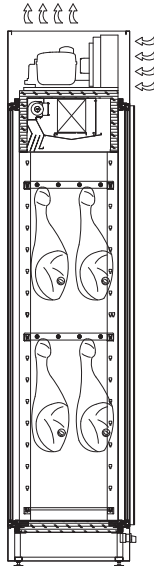
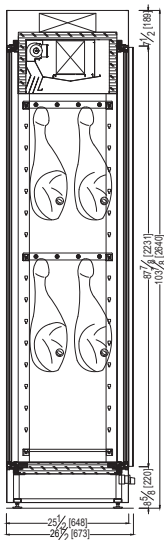

*Oscartek® reserves the right to change, modify, discontinue, or change any features, sizes, or capacity on any model without prior notice.

OSCARTEK®
512 South Airport Blvd., South San Francisco, CA 94080
Tel: 855.885.2400 | 650.342.2400 | Fax: 650.342.7400
sales@oscartek.com | www.oscartek.com





Discover the Art of Display...

Project Name: _____

Item #: _____ Quantity: _____

MODELS: GALA CC700, CC1400, CC1400-2T, CC2100, CC2100-2T, CC2800

GALA CHEESE & CHARCUTERIE - REMOTE							
TECHNICAL FEATURES		MODELS					
Model Name (Model ETL Code)		GALA CC700 (MUROGALA1P)	GALA CC1400 (MUROGALA2P)	GALA CC1400-2T (MUROGALA1P) X2	GALA CC2100 (MUROGALA3P)	GALA CC2100-2T (MUROGALA2P) (MUROGALA1P)	GALA CC2800 (MUROGALA4P)
External Dimensions (L-D-H) Inches-MM	Inches MM	*30 1/4" - 30 1/8" - 90 1/2" *780 - 765 - 2300	*58 1/4" - 30 1/8" - 90 1/2" *1480 - 765 - 2300	*58 1/4" - 30 1/8" - 90 1/2" *1480 - 765 - 2300	*85 7/8" - 30 1/8" - 90 1/2" *2180 - 765 - 2300	*85 7/8" - 30 1/8" - 90 1/2" *2180 - 765 - 2300	*113 3/8" - 30 1/8" - 90 1/2" *2880 - 765 - 2300
Crated Dimensions (L-D-H) Inches-MM	Inches MM	38" - 37" - 102" 960 - 920 - 2570	66" - 37" - 102" 1660 - 920 - 2570	66" - 37" - 102" 1660 - 920 - 2570	93" - 37" - 102" 2360 - 920 - 2570	93" - 37" - 102" 2360 - 920 - 2570	121" - 37" - 102" 3060 - 920 - 2570
Refrigeration	Type	Fan - Ventilated	Fan - Ventilated	Fan - Ventilated	Fan - Ventilated	Fan - Ventilated	Fan - Ventilated
Refrigeration Display Area	Type	Deck	Deck	Deck	Deck	Deck	Deck
Number of Glass Doors	#	1	2	2	3	3	4
Operating Temperature	°F	32°F to 41°F	32°F to 41°F	32°F to 41°F	32°F to 41°F	32°F to 41°F	32°F to 41°F
Condensing Units	#	1	2	2	3	4	5
Compressor	Nr./Type	1 / Hermetic	1 / Hermetic	1 / Hermetic	1 / Hermetic	2 / Hermetic	3 / Hermetic
BTU'S @ +14°F Evap Temperature	BTU/H	2870	5260	(2) 2750	7160	2750 5150	8400
Electric Supply	(V/Ph/Hz)	220/1/60	220/1/60	(2) 220/1/60	220/1/60	(2) 220/1/60	220/1/60
Power Consumption	(W/A)	620/3.5	1200/6.5	(2) 580/3.1	1800/9.6	580/3.1 1150/6.0	2300/12.5
Defrost	Mode/Type	Automatic	Automatic	Automatic	Automatic	Automatic	Automatic
Climatic Class	°F/%RH	75°F-55%RH	75°F-55%RH	75°F-55%RH	75°F-55%RH	75°F-55%RH	75°F-55%RH
Refrigerant Gas (remote/self-contained)	Type	R452a	R452a	R452a	R452a	R452a	R452a
Pipe Size (Suction-Liquid)	(INCHES)	15/32"- 15/64"	35/64" - 5/16"	(2) 15/32"- 15/64"	5/8" - 5/16"	15/32"- 15/64" 35/64" - 5/16"	45/64" - 25/64"
Net Weights	Lb	353	617	705	816	882	970
Crated Weights	Lb	403	677	765	876	942	1030

*DIMENSIONS WITH POLISHED S/S SIDES

GALA CHEESE & CHARCUTERIE - SELF CONTAINED							
TECHNICAL FEATURES		MODELS					
Model Name (Model ETL Code)		GALA CC700 (MUROGALA1P)	GALA CC1400 (MUROGALA2P)	GALA CC1400-2T (MUROGALA1P) X2	GALA CC2100 (MUROGALA3P)	GALA CC2100-2T (MUROGALA2P) (MUROGALA1P)	GALA CC2800 (MUROGALA4P)
External Dimensions (L-D-H) Inches-MM	Inches MM	*30 3/4" - 32 1/8" - 90 1/2" *780 - 815 - 2300	*58 1/4" - 32 1/8" - 90 1/2" *1480 - 815 - 2300	*58 1/4" - 32 1/8" - 90 1/2" *1480 - 815 - 2300	*85 7/8" - 32 1/8" - 90 1/2" *2180 - 815 - 2300	*85 7/8" - 32 1/8" - 90 1/2" *2180 - 815 - 2300	*113 3/8" - 32 1/8" - 90 1/2" *2880 - 815 - 2300
Crated Dimensions (L-D-H) Inches-MM	Inches MM	38" - 37" - 102" 960 - 920 - 2570	66" - 37" - 102" 1660 - 920 - 2570	66" - 37" - 102" 1660 - 920 - 2570	93" - 37" - 102" 2360 - 920 - 2570	93" - 37" - 102" 2360 - 920 - 2570	121" - 37" - 102" 3060 - 920 - 2570
Refrigeration	Type	Fan - Ventilated	Fan - Ventilated	Fan - Ventilated	Fan - Ventilated	Fan - Ventilated	Fan - Ventilated
Refrigeration Display Area	Type	Deck	Deck	Deck	Deck	Deck	Deck
Number of Glass Doors	#	1	2	2	3	3	4
Operating Temperature	°F	32°F to 41°F	32°F to 41°F	32°F to 41°F	32°F to 41°F	32°F to 41°F	32°F to 41°F
Condensing Units	#	1	2	2	3	4	5
Compressor	Nr./Type	1 / Hermetic	1 / Hermetic	1 / Hermetic	1 / Hermetic	2 / Hermetic	3 / Hermetic
BTU'S @ +14°F Evap Temperature	BTU/H	2870	5260	(2) 2750	7160	2750 5150	8400
Electric Supply	(V/Ph/Hz)	220/1/60	220/1/60	(2) 220/1/60	220/1/60	(2) 220/1/60	220/1/60
Power Consumption	(W/A)	620/3.5	1200/6.5	(2) 580/3.1	1800/9.6	580/3.1 1150/6.0	2300/12.5
Defrost	Mode/Type	Automatic	Automatic	Automatic	Automatic	Automatic	Automatic
Climatic Class	°F/%RH	75°F-55%RH	75°F-55%RH	75°F-55%RH	75°F-55%RH	75°F-55%RH	75°F-55%RH
Refrigerant Gas	Type	R290	R290	R290	R290	R290	R290
Pipe Size (Suction-Liquid)	(INCHES)	15/32"- 15/64"	35/64" - 5/16"	(2) 15/32"- 15/64"	5/8" - 5/16"	15/32"- 15/64" 35/64" - 5/16"	45/64" - 25/64"
Net Weights	Lb	353	617	705	816	882	970
Crated Weights	Lb	403	677	765	876	942	1030

*DIMENSIONS WITH POLISHED S/S SIDES

*Oscartek® reserves the right to change, modify, discontinue, or change any features, sizes, or capacity on any model without prior notice.

OSCARTEK®
512 South Airport Blvd., South San Francisco, CA 94080
Tel: 855.885.2400 | 650.342.2400 | Fax: 650.342.7400
sales@oscartek.com | www.oscartek.com





Discover the Art of Display...

Project Name: _____

Item #: _____ Quantity: _____

BACK WINDOW MODELS: GALA CC770BW, CC1370BW, CC1970BW

GALA CHEESE & CHARCUTERIE BACK WINDOW - REMOTE				
TECHNICAL FEATURES		MODELS		
Model Name (Model ETL Code)		GALA BW CC770 (MUROGALA1P)	GALA BW CC1370 (MUROGALA2P)	GALA BW CC1970 (MUROGALA3P)
External Dimensions (L-D-H)	Inches	*30 1/4" - 26 1/2" - 103 7/8"	*53 7/8" - 26 1/2" - 103 7/8"	*77 1/2" - 26 1/2" - 103 7/8"
Inches-MM	MM	*768 - 673 - 2640	*1368 - 673 - 2640	*1968 - 673 - 2640
Crated Dimensions (L-D-H)	Inches	38" - 33" - 115"	61" - 33" - 115"	85" - 33" - 115"
Inches-MM	MM	948 - 828 - 2910	1548 - 828 - 2910	2148 - 828 - 2910
Refrigeration	Type	Fan - Ventilated	Fan - Ventilated	Fan - Ventilated
Refrigeration Display Area	Type	Deck	Deck	Deck
Number of Glass Doors	#	1	2	3
Operating Temperature	°F	32°F to 41°F	32°F to 41°F	32°F to 41°F
Condensing Units	#	1	2	3
Compressor	Nr./Type	1 / Hermetic	1 / Hermetic	1 / Hermetic
BTU'S @ +14°F Evap Temperature	BTU/H	3400	5300	7680
Electric Supply	(V/Ph/Hz)	220/1/60	220/1/60	220/1/60
Power Consumption	(W/A)	1600/8.2	1800/9.8	2200/11.8
Defrost	Mode/Type	Automatic	Automatic	Automatic
Climatic Class	°F/%RH	75°F-55%RH	75°F-55%RH	75°F-55%RH
Refrigerant Gas	Type	R452a	R452a	R452a
Pipe Size (Suction-Liquid)	(INCHES)	15/32"- 15/64"	35/64" - 5/16"	5/8" - 5/16"
Net Weights	Lb	551	794	970
Crated Weights	Lb	611	854	1030

*DIMENSIONS WITH POLISHED S/S SIDES

GALA CHEESE & CHARCUTERIE BACK WINDOW - SELF CONTAINED				
TECHNICAL FEATURES		MODELS		
Model Name (Model ETL Code)		GALA BW CC770 (MUROGALA1P)	GALA BW CC1370 (MUROGALA2P)	GALA BW CC1970 (MUROGALA3P)
External Dimensions (L-D-H)	Inches	*30 1/4" - 26 1/2" - 111 3/4"	*53 7/8" - 26 1/2" - 111 3/4"	*77 1/2" - 26 1/2" - 111 3/4"
Inches-MM	MM	*768 - 673 - 2840	*1368 - 673 - 2840	*1968 - 673 - 2840
Crated Dimensions (L-D-H)	Inches	38" - 33" - 115"	61" - 33" - 115"	85" - 33" - 115"
Inches-MM	MM	948 - 828 - 2910	1548 - 828 - 2910	2148 - 828 - 2910
Refrigeration	Type	Fan - Ventilated	Fan - Ventilated	Fan - Ventilated
Refrigeration Display Area	Type	Deck	Deck	Deck
Number of Glass Doors	#	1	2	3
Operating Temperature	°F	32°F to 41°F	32°F to 41°F	32°F to 41°F
Condensing Units	#	1	2	3
Compressor	Nr./Type	1 / Hermetic	1 / Hermetic	1 / Hermetic
BTU'S @ +14°F Evap Temperature	BTU/H	3400	5300	7680
Electric Supply	(V/Ph/Hz)	220/1/60	220/1/60	220/1/60
Power Consumption	(W/A)	1600/8.2	1800/9.8	2200/11.8
Defrost	Mode/Type	Automatic	Automatic	Automatic
Climatic Class	°F/%RH	75°F-55%RH	75°F-55%RH	75°F-55%RH
Refrigerant Gas	Type	R455/R454c	R455/R454c	R455/R454c
Pipe Size (Suction-Liquid)	(INCHES)	15/32"- 15/64"	35/64" - 5/16"	5/8" - 5/16"
Net Weights	Lb	551	794	970
Crated Weights	Lb	611	854	1030

*DIMENSIONS WITH POLISHED S/S SIDES

*Oscartek® reserves the right to change, modify, discontinue, or change any features, sizes, or capacity on any model without prior notice.

OSCARTEK®

512 South Airport Blvd., South San Francisco, CA 94080

Tel: 855.885.2400 | 650.342.2400 | Fax: 650.342.7400

sales@oscartek.com | www.oscartek.com





Discover the Art of Display...

Project Name: _____

Item #: _____ Quantity: _____

PASS THROUGH MODELS: GALA CC770PT, CC1370PT, CC1970PT

GALA CHEESE & CHARCUTERIE PASS THROUGH - REMOTE				
TECHNICAL FEATURES		MODELS		
Model Name (Model ETL Code)		GALA PT CC770 (MUROGALA1P)	GALA PT CC1370 (MUROGALA2P)	GALA PT CC1970 (MUROGALA3P)
External Dimensions (L-D-H)	Inches	*30 1/4" - 26 1/2" - 103 7/8"	*53 7/8" - 26 1/2" - 103 7/8"	*77 1/2" - 26 1/2" - 103 7/8"
Inches-MM	MM	*768 - 673 - 2640	*1368 - 673 - 2640	*1968 - 673 - 2640
Crated Dimensions (L-D-H)	Inches	38" - 33" - 115"	61" - 33" - 115"	85" - 33" - 115"
Inches-MM	MM	948 - 828 - 2910	1548 - 828 - 2910	2148 - 828 - 2910
Refrigeration	Type	Fan - Ventilated	Fan - Ventilated	Fan - Ventilated
Refrigeration Display Area	Type	Deck	Deck	Deck
Number of Glass Doors	#	1	2	3
Operating Temperature	°F	32°F to 41°F	32°F to 41°F	32°F to 41°F
Condensing Units	#	1	2	3
Compressor	Nr./Type	1 / Hermetic	1 / Hermetic	1 / Hermetic
BTU'S @ +14°F Evap Temperature	BTU/H	3400	5300	7680
Electric Supply	(V/Ph/Hz)	220/1/60	220/1/60	220/1/60
Power Consumption	(W/A)	1600/8.2	1800/9.8	2200/11.8
Defrost	Mode/Type	Automatic	Automatic	Automatic
Climatic Class	°F/%RH	75°F-55%RH	75°F-55%RH	75°F-55%RH
Refrigerant Gas	Type	R452a	R452a	R452a
Pipe Size (Suction-Liquid)	(INCHES)	15/32" - 15/64"	35/64" - 5/16"	5/8" - 5/16"
Net Weights	Lb	573	838	1036
Crated Weights	Lb	633	898	1096

*DIMENSIONS WITH POLISHED S/S SIDES

GALA CHEESE & CHARCUTERIE PASS THROUGH - SELF CONTAINED				
TECHNICAL FEATURES		MODELS		
Model Name (Model ETL Code)		GALA PT CC770 (MUROGALA1P)	GALA PT CC1370 (MUROGALA2P)	GALA PT CC1970 (MUROGALA3P)
External Dimensions (L-D-H)	Inches	*30 1/4" - 26 1/2" - 111 3/4"	*53 7/8" - 26 1/2" - 111 3/4"	*77 1/2" - 26 1/2" - 111 3/4"
Inches-MM	MM	*768 - 673 - 2840	*1368 - 673 - 2840	*1968 - 673 - 2840
Crated Dimensions (L-D-H)	Inches	38" - 33" - 115"	61" - 33" - 115"	85" - 33" - 115"
Inches-MM	MM	948 - 828 - 2910	1548 - 828 - 2910	2148 - 828 - 2910
Refrigeration	Type	Fan - Ventilated	Fan - Ventilated	Fan - Ventilated
Refrigeration Display Area	Type	Deck	Deck	Deck
Number of Glass Doors	#	1	2	3
Operating Temperature	°F	32°F to 41°F	32°F to 41°F	32°F to 41°F
Condensing Units	#	1	2	3
Compressor	Nr./Type	1 / Hermetic	1 / Hermetic	1 / Hermetic
BTU'S @ +14°F Evap Temperature	BTU/H	3400	5300	7680
Electric Supply	(V/Ph/Hz)	220/1/60	220/1/60	220/1/60
Power Consumption	(W/A)	1600/8.2	1800/9.8	2200/11.8
Defrost	Mode/Type	Automatic	Automatic	Automatic
Climatic Class	°F/%RH	75°F-55%RH	75°F-55%RH	75°F-55%RH
Refrigerant Gas	Type	R455/R454c	R455/R454c	R455/R454c
Pipe Size (Suction-Liquid)	(INCHES)	15/32" - 15/64"	35/64" - 5/16"	5/8" - 5/16"
Net Weights	Lb	573	838	1036
Crated Weights	Lb	633	898	1096

*DIMENSIONS WITH POLISHED S/S SIDES

*Oscartek® reserves the right to change, modify, discontinue, or change any features, sizes, or capacity on any model without prior notice.

OSCARTEK®
512 South Airport Blvd., South San Francisco, CA 94080
Tel: 855.885.2400 | 650.342.2400 | Fax: 650.342.7400
sales@oscartek.com | www.oscartek.com





Gala Deli Pastry integrated into the wall of a cakery.

GALA DELI PASTRY

MODELS: GALA DP700, DP1400, DP1400-2T, DP2100, DP2100-2T, DP2800

BACK WINDOW MODELS: GALA DP770BW, DP1370BW, DP1970BW

PASS THROUGH MODELS: GALA DP770PT, DP1370PT, DP1970PT

STANDARD FEATURES

- Solid Sides
- Dual Medium Temperature Version with intermediate double glass divider
- Triple pane glass premium door
- Steel load bearing structure
- 3000°K LED lighting with dimmer switch
- Touch Control
- Ventilated cooling
- interior vertical shelf support in stainless steel
- adjustable feet
- standard steel 304A
- stainless steel interior and exterior
- Stainless steel shelves adjustable in height on racks
- programmed automatic electric defrost
- Approvals: cETLus, ETL sanitation, certified CE
- Remote condensing unit
- Condensate evaporator pan
- **Back Window & Pass Through:** glass shelving, glass sides
- **Back Window:** rear glass side
- **Pass Through:** rear glass door

Visit our website for optional RAL colors and Materials finishes.

[RAL Colors Website](#)

[Materials Brochure PDF](#)

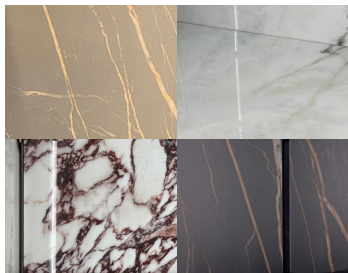

Examples of optional 6mm thick stone back panel behind shelf. For full selection see our Materials Brochure.

OPTIONS



- RAL Color Option powder coated door handles exterior and interior over stainless
- Front wood laminate door and handles
- interior shelf trim
- 6mm thick stone back panel behind shelf
- Glass Sides
- Wooden exterior
- top door and interior shelf trim
- Bottom mount condensing unit
- Top mounted condensing unit
- water cooled
- central refrigeration rack
- 60 Hz components UL
- 6mm thick stone back panel behind shelf
- Glass Sides
- Narrow Depth
- front breathing available for 1400L - 2800L models

*Oscartek® reserves the right to change, modify, discontinue, or change any features, sizes, or capacity on any model without prior notice.

OSCARTEK®
512 South Airport Blvd., South San Francisco, CA 94080
Tel: 855.885.2400 | 650.342.2400 | Fax: 650.342.7400
sales@oscartek.com | www.oscartek.com



MODELS: GALA DP700, DP1400, DP1400-2T, DP2100, DP2100-2T, DP2800
BACK WINDOW MODELS: GALA DP770BW, DP1370BW, DP1970BW
PASS THROUGH MODELS: GALA DP770PT, DP1370PT, DP1970PT

ELECTRICAL LEGEND	
	REFRIGERATION LINES
	DRAIN
	POWER

GALA DELI PASTRY
PLAN VIEWS

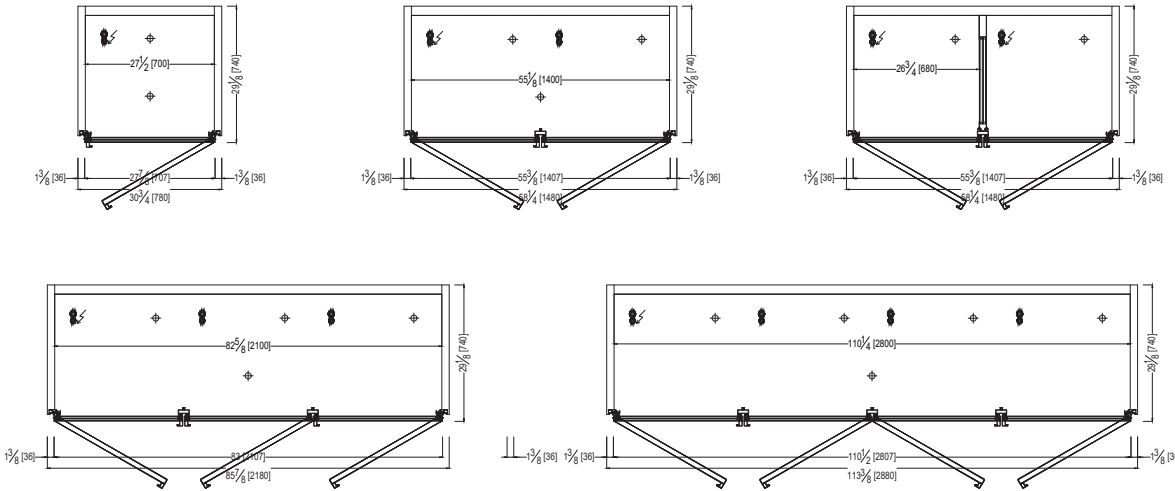

BACK WINDOW
PLAN VIEWS

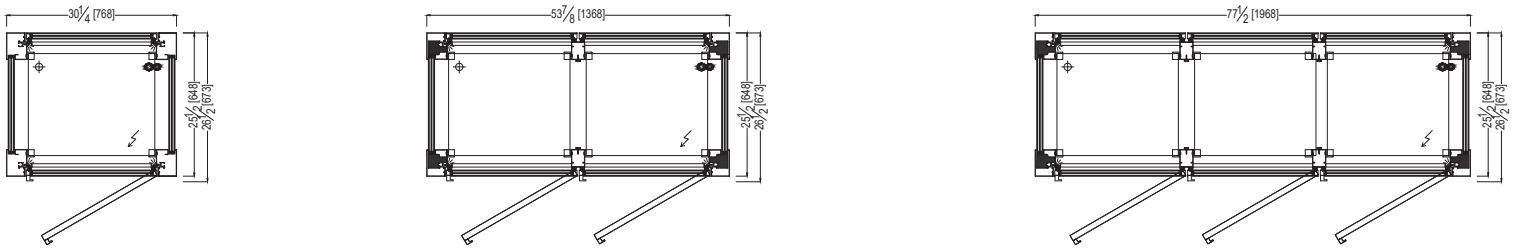

PASS THROUGH
PLAN VIEWS

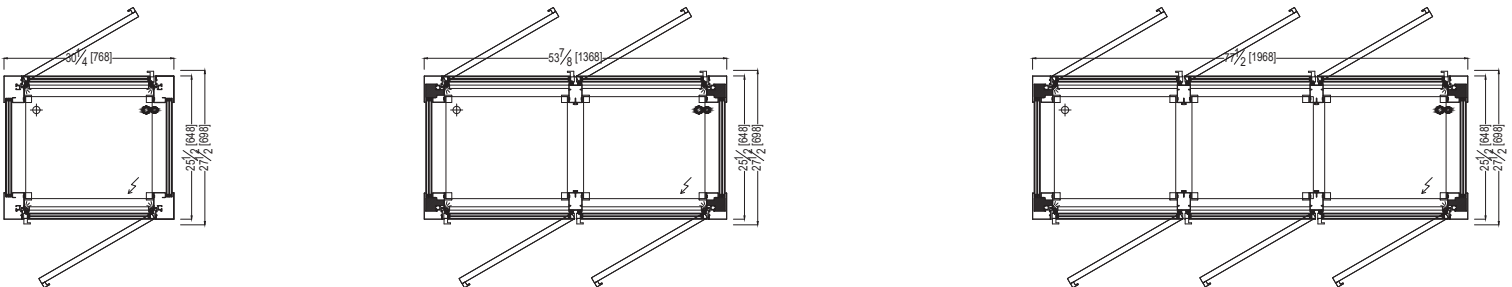

*Oscartek® reserves the right to change, modify, discontinue, or change any features, sizes, or capacity on any model without prior notice.

MODELS: GALA DP700, DP1400, DP1400-2T, DP2100, DP2100-2T, DP2800

BACK WINDOW MODELS: GALA DP770BW, DP1370BW, DP1970BW

PASS THROUGH MODELS: GALA DP770PT, DP1370PT, DP1970PT

GALA DELI PASTRY
FRONT ELEVATIONS

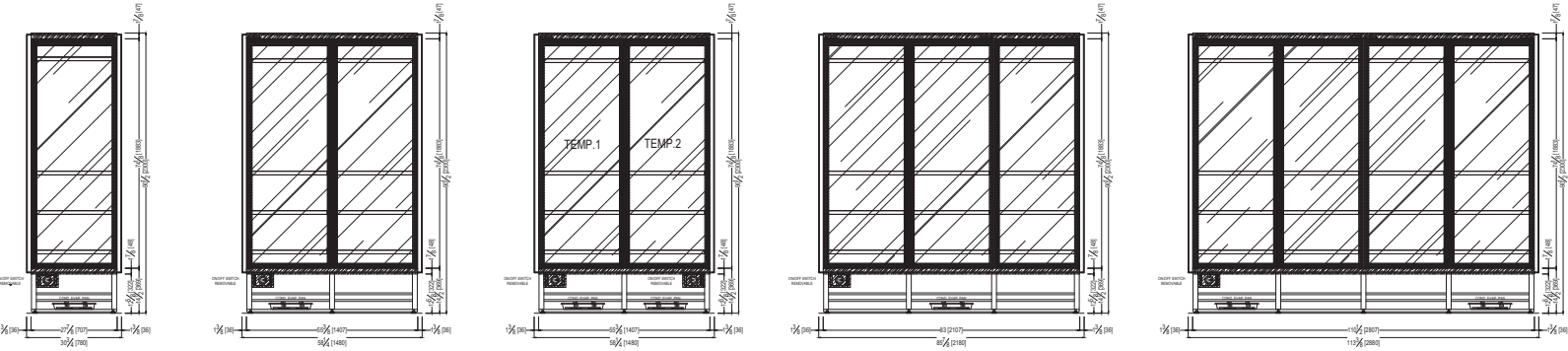

BACK WINDOW & PASS THROUGH
FRONT ELEVATIONS

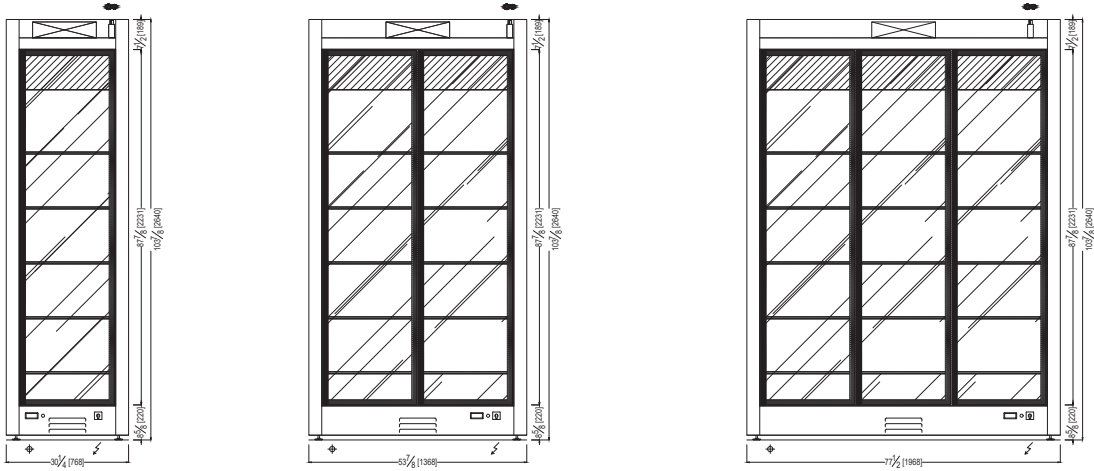

WALL CUT OUT ELEVATIONS

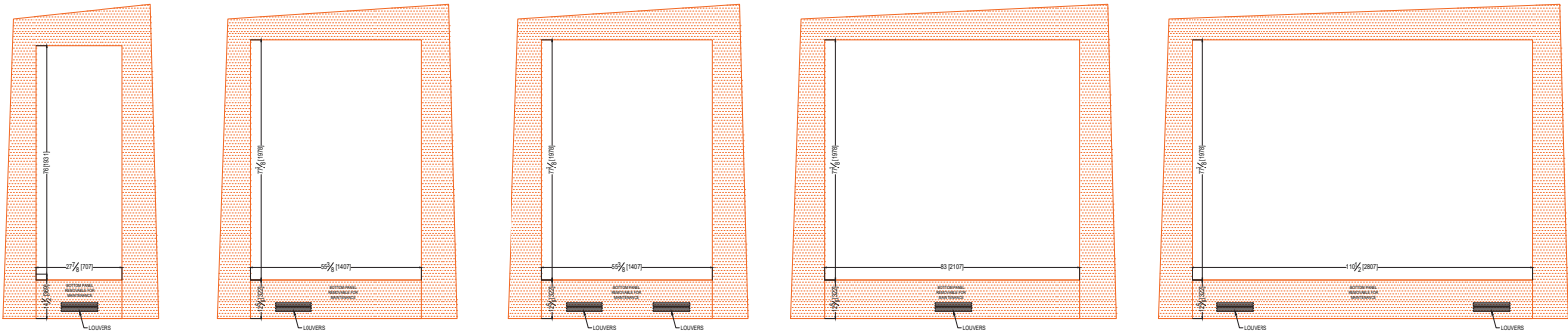

*Oscartek® reserves the right to change, modify, discontinue, or change any features, sizes, or capacity on any model without prior notice.

MODELS: GALA DP700, DP1400, DP1400-2T, DP2100, DP2100-2T, DP2800

BACK WINDOW MODELS: GALA DP770BW, DP1370BW, DP1970BW

PASS THROUGH MODELS: GALA DP770PT, DP1370PT, DP1970PT

GALA DELI PASTRY - STANDARD DEPTH
SECTION VIEWS

**STANDARD:
REMOTE**

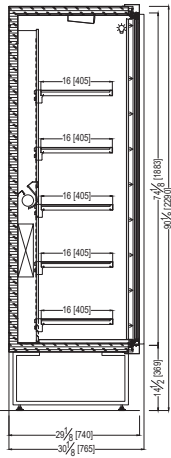

**STANDARD:
SELF-CONTAINED
WITH
GLASS SIDE**

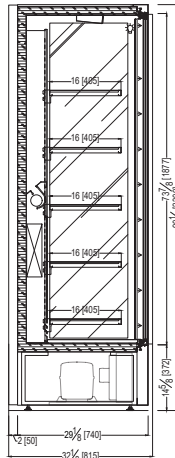

**OPTIONAL:
TOP MOUNTED
CONDENSING
UNIT**

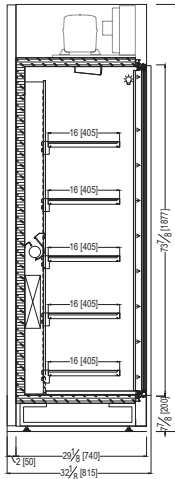

**OPTIONAL:
WOODEN
EXTERIOR**

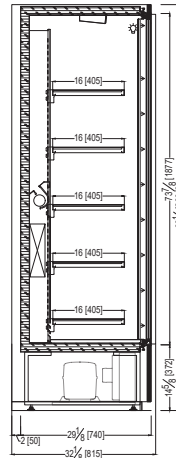

NARROW DEPTH
SECTION VIEWS

**STANDARD:
REMOTE**

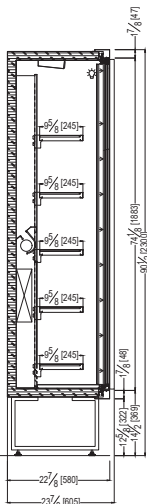

**STANDARD:
SELF-CONTAINED**

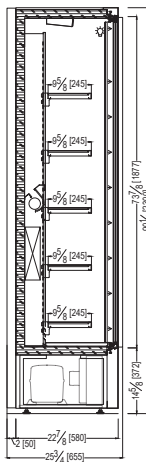

**OPTIONAL:
TOP MOUNTED
CONDENSING
UNIT**

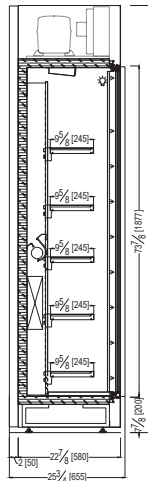

*Oscartek® reserves the right to change, modify, discontinue, or change any features, sizes, or capacity on any model without prior notice.

OSCARTEK®
512 South Airport Blvd., South San Francisco, CA 94080
Tel: 855.885.2400 | 650.342.2400 | Fax: 650.342.7400
sales@oscartek.com | www.oscartek.com



MODELS: GALA DP700, DP1400, DP1400-2T, DP2100, DP2100-2T, DP2800

BACK WINDOW MODELS: GALA DP770BW, DP1370BW, DP1970BW

PASS THROUGH MODELS: GALA DP770PT, DP1370PT, DP1970PT

GALA DELI PASTRY - BACK WINDOW & PASS THROUGH SECTION VIEWS

**STANDARD:
BACK WINDOW
REMOTE**

**OPTIONAL:
TOP MOUNTED
CONDENSING UNIT**

**STANDARD:
PASS THROUGH
REMOTE**

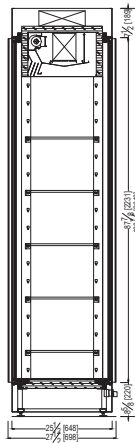
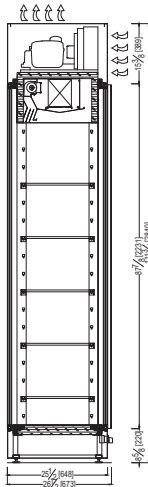
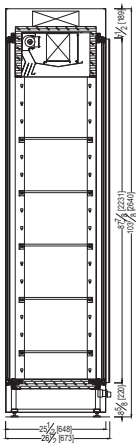

*Oscartek® reserves the right to change, modify, discontinue, or change any features, sizes, or capacity on any model without prior notice.

OSCARTEK®
512 South Airport Blvd., South San Francisco, CA 94080
Tel: 855.885.2400 | 650.342.2400 | Fax: 650.342.7400
sales@oscartek.com | www.oscartek.com





Discover the Art of Display...

Project Name: _____

Item #: _____ Quantity: _____

MODELS: GALA DP700, DP1400, DP1400-2T, DP2100, DP2100-2T, DP2800

TECHNICAL FEATURES		GALA DELI PASTRY - REMOTE					
Model Name (Model ETL Code)		GALA DP700 (MUROGALA1P)	GALA DP1400 (MUROGALA2P)	GALA DP1400-2T (MUROGALA1P) X2	GALA DP2100 (MUROGALA3P)	GALA DP2100-2T (MUROGALA2P) (MUROGALA1P)	GALA DP2800 (MUROGALA4P)
External Dimensions (L-D-H) Inches-MM	Inches MM	*30 1/4" - 30 1/8" - 90 1/2" *780 - 765 - 2300	*58 1/4" - 30 1/8" - 90 1/2" *1480 - 765 - 2300	*58 1/4" - 30 1/8" - 90 1/2" *1480 - 765 - 2300	*85 7/8" - 30 1/8" - 90 1/2" *2180 - 765 - 2300	*85 7/8" - 30 1/8" - 90 1/2" *2180 - 765 - 2300	*113 3/8" - 30 1/8" - 90 1/2" *2880 - 765 - 2300
Crated Dimensions (L-D-H) Inches-MM	Inches MM	38" - 37" - 102" 960 - 920 - 2570	66" - 37" - 102" 1660 - 920 - 2570	66" - 37" - 102" 1660 - 920 - 2570	93" - 37" - 102" 2360 - 920 - 2570	93" - 37" - 102" 2360 - 920 - 2570	121" - 37" - 102" 3060 - 920 - 2570
Refrigeration	Type	Fan - Ventilated	Fan - Ventilated	Fan - Ventilated	Fan - Ventilated	Fan - Ventilated	Fan - Ventilated
Refrigeration Display Area	Type	Deck	Deck	Deck	Deck	Deck	Deck
Number of Glass Doors	#	1	2	2	3	3	4
Operating Temperature	°F	32°F to 41°F	32°F to 41°F	32°F to 41°F	32°F to 41°F	32°F to 41°F	32°F to 41°F
Condensing Units	#	1	2	2	3	4	5
Compressor	Nr./Type	1 / Hermetic	1 / Hermetic	1 / Hermetic	1 / Hermetic	2 / Hermetic	3 / Hermetic
BTU'S @ +14°F Evap Temperature	BTU/H	2870	5260	(2) 2750	7160	5150	8400
Electric Supply	(V/Ph/Hz)	220/1/60	220/1/60	(2) 220/1/60	220/1/60	(2) 220/1/60	220/1/60
Power Consumption	(W/A)	620/3.5	1200/6.5	(2) 580/3.1	1800/9.6	580/3.1 1150/6.0	2300/12.5
Defrost	Mode/Type	Automatic	Automatic	Automatic	Automatic	Automatic	Automatic
Climatic Class	°F/%RH	75°F-55%RH	75°F-55%RH	75°F-55%RH	75°F-55%RH	75°F-55%RH	75°F-55%RH
Refrigerant Gas (remote/self-contained)	Type	R452a	R452a	R452a	R452a	R452a	R452a
Pipe Size (Suction-Liquid)	(INCHES)	15/32" - 15/64"	35/64" - 5/16"	(2) 15/32" - 15/64"	5/8" - 5/16"	15/32" - 15/64"	45/64" - 25/64"
Net Weights	Lb	353	617	705	816	882	970
Crated Weights	Lb	403	677	765	876	942	1030

*DIMENSIONS WITH POLISHED S/S SIDES

TECHNICAL FEATURES		GALA DELI PASTRY - SELF CONTAINED					
Model Name (Model ETL Code)		GALA DP700 (MUROGALA1P)	GALA DP1400 (MUROGALA2P)	GALA DP1400-2T (MUROGALA1P) X2	GALA DP2100 (MUROGALA3P)	GALA DP2100-2T (MUROGALA2P) (MUROGALA1P)	GALA DP2800 (MUROGALA4P)
External Dimensions (L-D-H) Inches-MM	Inches MM	*30 3/4" - 32 1/8" - 90 1/2" *780 - 815 - 2300	*58 1/4" - 32 1/8" - 90 1/2" *1480 - 815 - 2300	*58 1/4" - 32 1/8" - 90 1/2" *1480 - 815 - 2300	*85 7/8" - 32 1/8" - 90 1/2" *2180 - 815 - 2300	*85 7/8" - 32 1/8" - 90 1/2" *2180 - 815 - 2300	*113 3/8" - 32 1/8" - 90 1/2" *2880 - 815 - 2300
Crated Dimensions (L-D-H) Inches-MM	Inches MM	38" - 37" - 102" 960 - 920 - 2570	66" - 37" - 102" 1660 - 920 - 2570	66" - 37" - 102" 1660 - 920 - 2570	93" - 37" - 102" 2360 - 920 - 2570	93" - 37" - 102" 2360 - 920 - 2570	121" - 37" - 102" 3060 - 920 - 2570
Refrigeration	Type	Fan - Ventilated	Fan - Ventilated	Fan - Ventilated	Fan - Ventilated	Fan - Ventilated	Fan - Ventilated
Refrigeration Display Area	Type	Deck	Deck	Deck	Deck	Deck	Deck
Number of Glass Doors	#	1	2	2	3	3	4
Operating Temperature	°F	32°F to 41°F	32°F to 41°F	32°F to 41°F	32°F to 41°F	32°F to 41°F	32°F to 41°F
Condensing Units	#	1	2	2	3	4	5
Compressor	Nr./Type	1 / Hermetic	1 / Hermetic	1 / Hermetic	1 / Hermetic	2 / Hermetic	3 / Hermetic
BTU'S @ +14°F Evap Temperature	BTU/H	2870	5260	(2) 2750	7160	5150	8400
Electric Supply	(V/Ph/Hz)	220/1/60	220/1/60	(2) 220/1/60	220/1/60	(2) 220/1/60	220/1/60
Power Consumption	(W/A)	620/3.5	1200/6.5	(2) 580/3.1	1800/9.6	580/3.1 1150/6.0	2300/12.5
Defrost	Mode/Type	Automatic	Automatic	Automatic	Automatic	Automatic	Automatic
Climatic Class	°F/%RH	75°F-55%RH	75°F-55%RH	75°F-55%RH	75°F-55%RH	75°F-55%RH	75°F-55%RH
Refrigerant Gas	Type	R290	R290	R290	R290	R290	R290
Pipe Size (Suction-Liquid)	(INCHES)	15/32" - 15/64"	35/64" - 5/16"	(2) 15/32" - 15/64"	5/8" - 5/16"	15/32" - 15/64"	45/64" - 25/64"
Net Weights	Lb	353	617	705	816	882	970
Crated Weights	Lb	403	677	765	876	942	1030

*DIMENSIONS WITH POLISHED S/S SIDES

*Oscartek® reserves the right to change, modify, discontinue, or change any features, sizes, or capacity on any model without prior notice.

OSCARTEK®
512 South Airport Blvd., South San Francisco, CA 94080
Tel: 855.885.2400 | 650.342.2400 | Fax: 650.342.7400
sales@oscartek.com | www.oscartek.com





Discover the Art of Display...

Project Name: _____

Item #: _____ Quantity: _____

BACK WINDOW MODELS: GALA DP770BW, DP1370BW, DP1970BW

GALA DELI PASTRY BACK WINDOW - REMOTE				
TECHNICAL FEATURES		MODELS		
Model Name (Model ETL Code)		GALA BW DP770 (MUROGALA1P)	GALA BW DP1370 (MUROGALA2P)	GALA BW DP1970 (MUROGALA3P)
External Dimensions (L-D-H) Inches-MM	Inches MM	*30 1/4" - 26 1/2" - 103 7/8" *768 - 673 - 2640	*53 7/8" - 26 1/2" - 103 7/8" *1368 - 673 - 2640	*77 1/2" - 26 1/2" - 103 7/8" *1968 - 673 - 2640
Crated Dimensions (L-D-H) Inches-MM	Inches MM	38" - 33" - 115" 948 - 828 - 2910	61" - 33" - 115" 1548 - 828 - 2910	85" - 33" - 115" 2148 - 828 - 2910
Refrigeration	Type	Fan - Ventilated	Fan - Ventilated	Fan - Ventilated
Refrigeration Display Area	Type	Deck	Deck	Deck
Number of Glass Doors	#	1	2	3
Operating Temperature	°F	32°F to 41°F	32°F to 41°F	32°F to 41°F
Condensing Units	#	1	2	3
Compressor	Nr./Type	1 / Hermetic	1 / Hermetic	1 / Hermetic
BTU'S @ +14°F Evap Temperature	BTU/H	3400	5300	7680
Electric Supply	(V/Ph/Hz)	220/1/60	220/1/60	220/1/60
Power Consumption	(W/A)	1600/8.2	1800/9.8	2200/11.8
Defrost	Mode/Type	Automatic	Automatic	Automatic
Climatic Class	°F/%RH	75°F-55%RH	75°F-55%RH	75°F-55%RH
Refrigerant Gas	Type	R452a	R452a	R452a
Pipe Size (Suction-Liquid)	(INCHES)	15/32"- 15/64"	35/64" - 5/16"	5/8" - 5/16"
Net Weights	Lb	551	794	970
Crated Weights	Lb	611	854	1030

*DIMENSIONS WITH POLISHED S/S SIDES

GALA DELI PASTRY BACK WINDOW - SELF CONTAINED				
TECHNICAL FEATURES		MODELS		
Model Name (Model ETL Code)		GALA BW DP770 (MUROGALA1P)	GALA BW DP1370 (MUROGALA2P)	GALA BW DP1970 (MUROGALA3P)
External Dimensions (L-D-H) Inches-MM	Inches MM	*30 1/4" - 26 1/2" - 111 3/4" *768 - 673 - 2840	*53 7/8" - 26 1/2" - 111 3/4" *1368 - 673 - 2840	*77 1/2" - 26 1/2" - 111 3/4" *1968 - 673 - 2840
Crated Dimensions (L-D-H) Inches-MM	Inches MM	38" - 33" - 115" 948 - 828 - 2910	61" - 33" - 115" 1548 - 828 - 2910	85" - 33" - 115" 2148 - 828 - 2910
Refrigeration	Type	Fan - Ventilated	Fan - Ventilated	Fan - Ventilated
Refrigeration Display Area	Type	Deck	Deck	Deck
Number of Glass Doors	#	1	2	3
Operating Temperature	°F	32°F to 41°F	32°F to 41°F	32°F to 41°F
Condensing Units	#	1	2	3
Compressor	Nr./Type	1 / Hermetic	1 / Hermetic	1 / Hermetic
BTU'S @ +14°F Evap Temperature	BTU/H	3400	5300	7680
Electric Supply	(V/Ph/Hz)	220/1/60	220/1/60	220/1/60
Power Consumption	(W/A)	1600/8.2	1800/9.8	2200/11.8
Defrost	Mode/Type	Automatic	Automatic	Automatic
Climatic Class	°F/%RH	75°F-55%RH	75°F-55%RH	75°F-55%RH
Refrigerant Gas	Type	R455/R454c	R455/R454c	R455/R454c
Pipe Size (Suction-Liquid)	(INCHES)	15/32"- 15/64"	35/64" - 5/16"	5/8" - 5/16"
Net Weights	Lb	551	794	970
Crated Weights	Lb	611	854	1030

*DIMENSIONS WITH POLISHED S/S SIDES

*Oscartek® reserves the right to change, modify, discontinue, or change any features, sizes, or capacity on any model without prior notice.

OSCARTEK®
512 South Airport Blvd., South San Francisco, CA 94080
Tel: 855.885.2400 | 650.342.2400 | Fax: 650.342.7400
sales@oscartek.com | www.oscartek.com





Discover the Art of Display...

Project Name: _____

Item #: _____ Quantity: _____

PASS THROUGH MODELS: GALA DP770PT, DP1370PT, DP1970PT

GALA DELI PASTRY PASS THROUGH - REMOTE				
TECHNICAL FEATURES		MODELS		
Model Name (Model ETL Code)		GALA PT DP770 (MUROGALA1P)	GALA PT DP1370 (MUROGALA2P)	GALA PT DP1970 (MUROGALA3P)
External Dimensions (L-D-H)	Inches	*30 1/4" - 26 1/2" - 103 7/8"	*53 7/8" - 26 1/2" - 103 7/8"	*77 1/2" - 26 1/2" - 103 7/8"
Inches-MM	MM	*768 - 673 - 2640	*1368 - 673 - 2640	*1968 - 673 - 2640
Crated Dimensions (L-D-H)	Inches	38" - 33" - 115"	61" - 33" - 115"	85" - 33" - 115"
Inches-MM	MM	948 - 828 - 2910	1548 - 828 - 2910	2148 - 828 - 2910
Refrigeration	Type	Fan - Ventilated	Fan - Ventilated	Fan - Ventilated
Refrigeration Display Area	Type	Deck	Deck	Deck
Number of Glass Doors	#	1	2	3
Operating Temperature	°F	32°F to 41°F	32°F to 41°F	32°F to 41°F
Condensing Units	#	1	2	3
Compressor	Nr./Type	1 / Hermetic	1 / Hermetic	1 / Hermetic
BTU'S @ +14°F Evap Temperature	BTU/H	3400	5300	7680
Electric Supply	(V/Ph/Hz)	220/1/60	220/1/60	220/1/60
Power Consumption	(W/A)	1600/8.2	1800/9.8	2200/11.8
Defrost	Mode/Type	Automatic	Automatic	Automatic
Climatic Class	°F/%RH	75°F-55%RH	75°F-55%RH	75°F-55%RH
Refrigerant Gas	Type	R452a	R452a	R452a
Pipe Size (Suction-Liquid)	(INCHES)	15/32"- 15/64"	35/64" - 5/16"	5/8" - 5/16"
Net Weights	Lb	573	838	1036
Crated Weights	Lb	633	898	1096

*DIMENSIONS WITH POLISHED S/S SIDES

GALA DELI PASTRY PASS THROUGH - SELF CONTAINED				
TECHNICAL FEATURES		MODELS		
Model Name (Model ETL Code)		GALA PT DP770 (MUROGALA1P)	GALA PT DP1370 (MUROGALA2P)	GALA PT DP1970 (MUROGALA3P)
External Dimensions (L-D-H)	Inches	*30 1/4" - 26 1/2" - 111 3/4"	*53 7/8" - 26 1/2" - 111 3/4"	*77 1/2" - 26 1/2" - 111 3/4"
Inches-MM	MM	*768 - 673 - 2840	*1368 - 673 - 2840	*1968 - 673 - 2840
Crated Dimensions (L-D-H)	Inches	38" - 33" - 115"	61" - 33" - 115"	85" - 33" - 115"
Inches-MM	MM	948 - 828 - 2910	1548 - 828 - 2910	2148 - 828 - 2910
Refrigeration	Type	Fan - Ventilated	Fan - Ventilated	Fan - Ventilated
Refrigeration Display Area	Type	Deck	Deck	Deck
Number of Glass Doors	#	1	2	3
Operating Temperature	°F	32°F to 41°F	32°F to 41°F	32°F to 41°F
Condensing Units	#	1	2	3
Compressor	Nr./Type	1 / Hermetic	1 / Hermetic	1 / Hermetic
BTU'S @ +14°F Evap Temperature	BTU/H	3400	5300	7680
Electric Supply	(V/Ph/Hz)	220/1/60	220/1/60	220/1/60
Power Consumption	(W/A)	1600/8.2	1800/9.8	2200/11.8
Defrost	Mode/Type	Automatic	Automatic	Automatic
Climatic Class	°F/%RH	75°F-55%RH	75°F-55%RH	75°F-55%RH
Refrigerant Gas	Type	R455/R454c	R455/R454c	R455/R454c
Pipe Size (Suction-Liquid)	(INCHES)	15/32"- 15/64"	35/64" - 5/16"	5/8" - 5/16"
Net Weights	Lb	573	838	1036
Crated Weights	Lb	633	898	1096

*DIMENSIONS WITH POLISHED S/S SIDES

*Oscartek® reserves the right to change, modify, discontinue, or change any features, sizes, or capacity on any model without prior notice.

OSCARTEK®
 512 South Airport Blvd., South San Francisco, CA 94080
 Tel: 855.885.2400 | 650.342.2400 | Fax: 650.342.7400
 sales@oscartek.com | www.oscartek.com



GALA RED MEAT

MODELS:

GALA RM700, RM1400, RM1400-2T, RM2100, RM2100-2T, RM2800

BACK WINDOW MODELS: GALA RM770BW, RM1370BW, RM1970BW

PASS THROUGH MODELS: GALA RM770PT, RM1370PT, RM1970PT



Gala Red Meat with rear loading doors.

STANDARD FEATURES

- Solid Sides
- Dual Medium Temperature Version with intermediate double glass divider
- Triple pane glass premium door
- Steel load bearing structure
- 3000°K LED lighting with dimmer switch
- Touch Control
- Ventilated cooling
- interior vertical shelf support in stainless steel
- adjustable feet
- standard steel 304A
- stainless steel interior and exterior
- Stainless steel shelves adjustable in height and hanging racks
- programmed automatic electric defrost
- Approvals: cETLus, ETL sanitation, certified CE
- Remote condensing unit
- Condensate evaporator pan
- **Back Window & Pass Through:** glass shelving, glass sides
- **Back Window:** rear glass side
- **Pass Through:** rear glass door

Visit our website for optional RAL colors and Materials finishes.

[RAL Colors Website](#)

[Materials Brochure PDF](#)

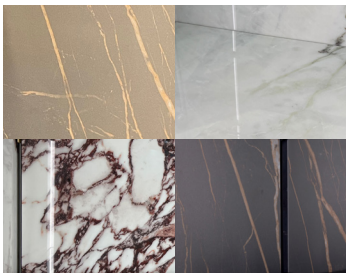

Examples of optional 6mm thick stone back panel behind shelf. For full selection see our Materials Brochure.

OPTIONS

- RAL Color Option powder coated door handles exterior and interior over stainless
- Front wood laminate door and handles
- interior shelf trim
- 6mm thick stone back panel behind shelf
- Glass Sides
- Wooden exterior
- top door and interior shelf trim
- Bottom mount condensing unit
- Top mounted condensing unit
- water cooled
- central refrigeration rack
- 60 Hz components UL
- 6mm thick stone back panel behind shelf
- Glass Sides
- Narrow Depth
- front breathing available for 1400L - 2800L models



*Oscartek® reserves the right to change, modify, discontinue, or change any features, sizes, or capacity on any model without prior notice.

Discover the Art of Display...

MODELS: GALA RM700, RM1400, RM1400-2T, RM2100, RM2100-2T, RM2800

BACK WINDOW MODELS: GALA RM770BW, RM1370BW, RM1970BW

PASS THROUGH MODELS: GALA RM770PT, RM1370PT, RM1970PT

ELECTRICAL LEGEND	
	REFRIGERATION LINES
	DRAIN
	POWER

GALA RED MEAT
PLAN VIEWS

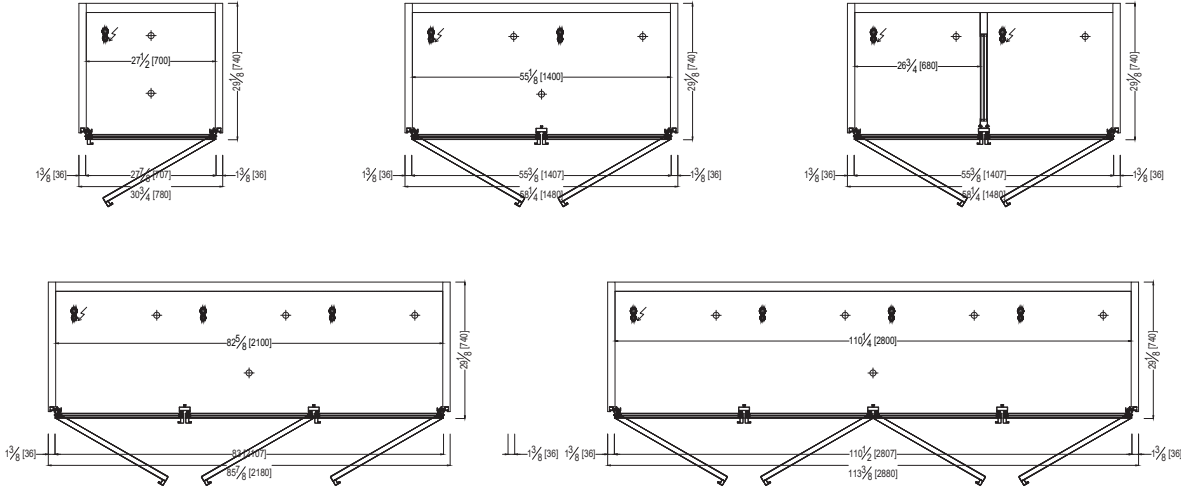

BACK WINDOW
PLAN VIEWS

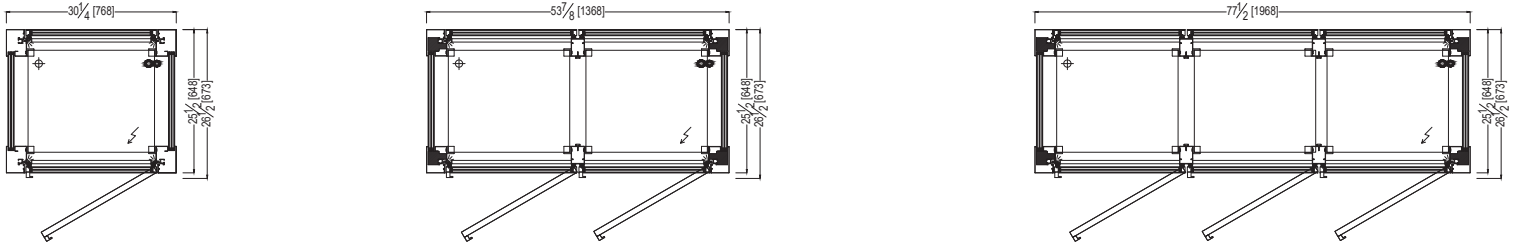

PASS THROUGH
PLAN VIEWS

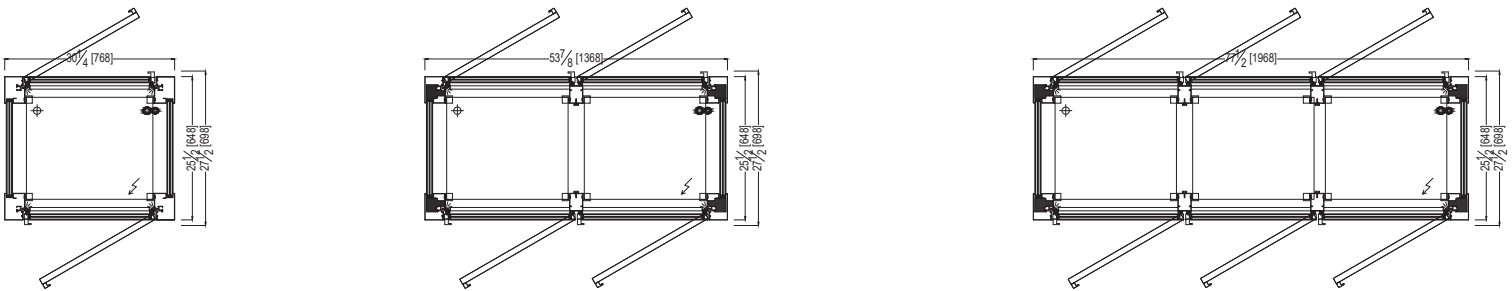

*Oscartek® reserves the right to change, modify, discontinue, or change any features, sizes, or capacity on any model without prior notice.

OSCARTEK®
512 South Airport Blvd., South San Francisco, CA 94080
Tel: 855.885.2400 | 650.342.2400 | Fax: 650.342.7400
sales@oscartek.com | www.oscartek.com



Discover the Art of Display...

MODELS: GALA RM700, RM1400, RM1400-2T, RM2100, RM2100-2T, RM2800

BACK WINDOW MODELS: GALA RM770BW, RM1370BW, RM1970BW

PASS THROUGH MODELS: GALA RM770PT, RM1370PT, RM1970PT

GALA RED MEAT
FRONT ELEVATIONS

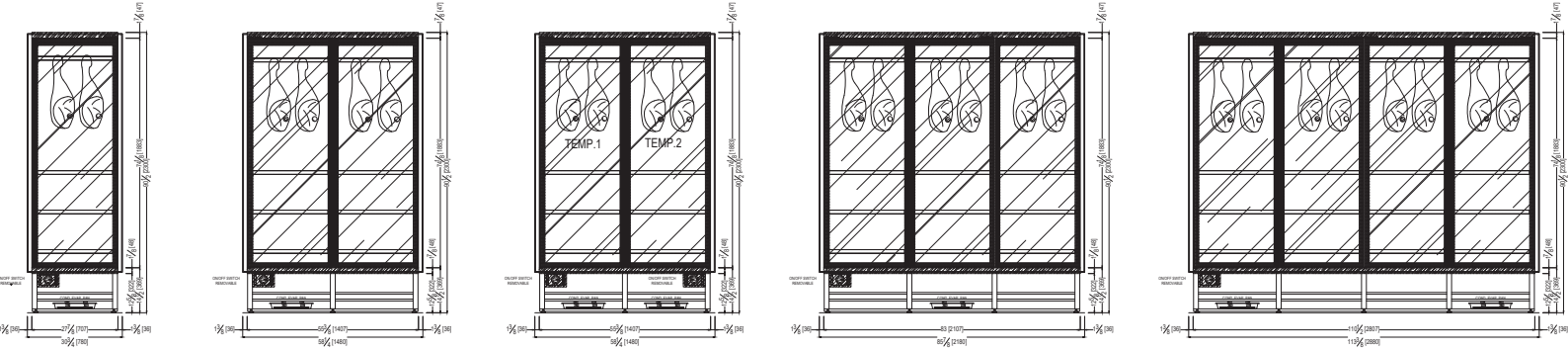

BACK WINDOW & PASS THROUGH
FRONT ELEVATIONS

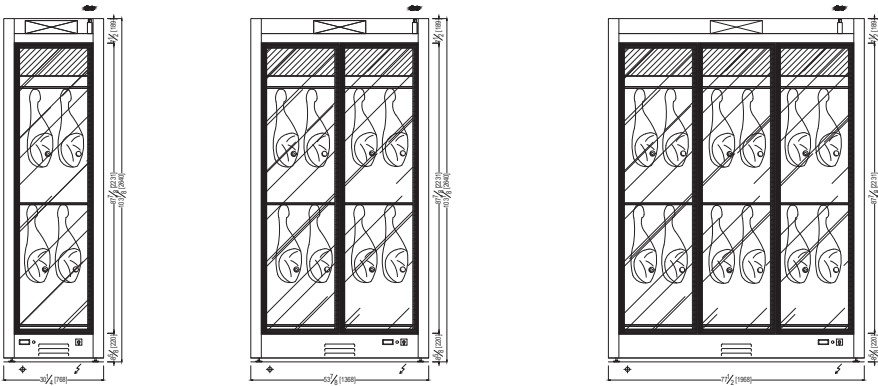

WALL CUT OUT ELEVATIONS

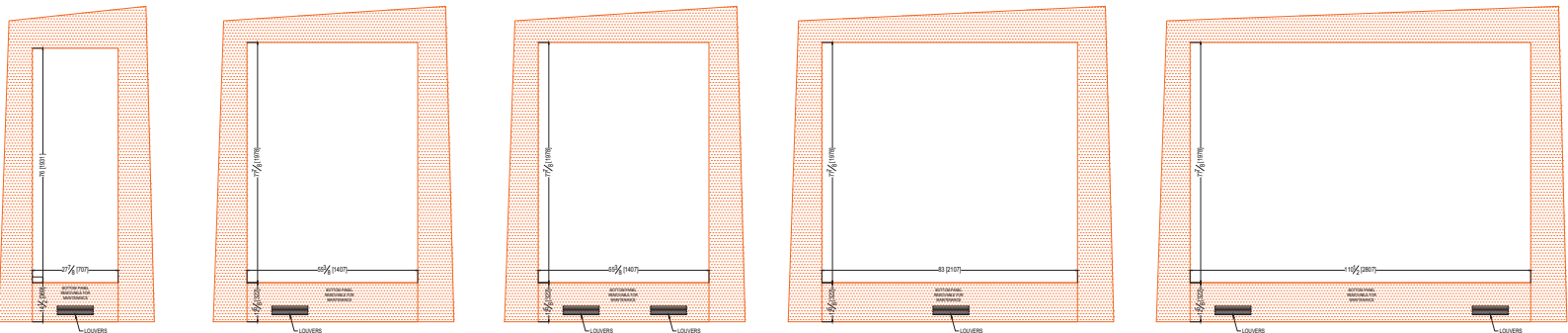

*Oscartek® reserves the right to change, modify, discontinue, or change any features, sizes, or capacity on any model without prior notice.

OSCARTEK®
512 South Airport Blvd., South San Francisco, CA 94080
Tel: 855.885.2400 | 650.342.2400 | Fax: 650.342.7400
sales@oscartek.com | www.oscartek.com



MODELS: GALA RM700, RM1400, RM1400-2T, RM2100, RM2100-2T, RM2800

BACK WINDOW MODELS: GALA RM770BW, RM1370BW, RM1970BW

PASS THROUGH MODELS: GALA RM770PT, RM1370PT, RM1970PT

GALA RED MEAT - STANDARD DEPTH
SECTION VIEWS

**STANDARD:
REMOTE**

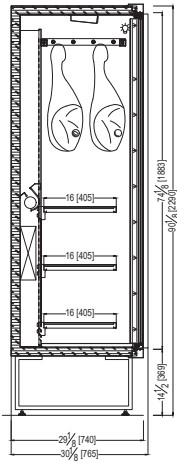

**STANDARD:
SELF-CONTAINED
WITH
GLASS SIDE**

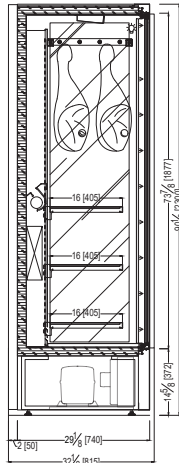

**OPTIONAL:
TOP MOUNTED
CONDENSING
UNIT**

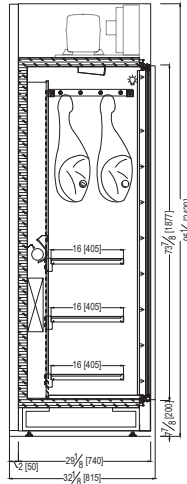

**OPTIONAL:
WOODEN
EXTERIOR**

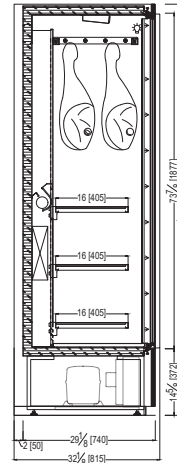

NARROW DEPTH
SECTION VIEWS

**STANDARD:
REMOTE**

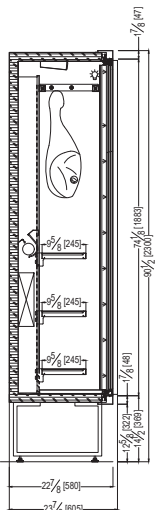

**STANDARD:
SELF-CONTAINED**

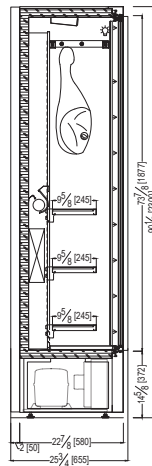

**OPTIONAL:
TOP MOUNTED
CONDENSING
UNIT**

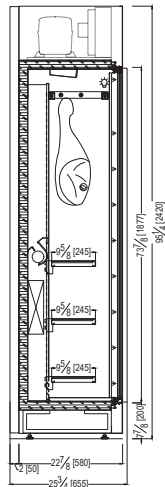

*Oscartek® reserves the right to change, modify, discontinue, or change any features, sizes, or capacity on any model without prior notice.

MODELS: GALA RM700, RM1400, RM1400-2T, RM2100, RM2100-2T, RM2800

BACK WINDOW MODELS: GALA RM770BW, RM1370BW, RM1970BW

PASS THROUGH MODELS: GALA RM770PT, RM1370PT, RM1970PT

GALA RED MEAT - BACK WINDOW & PASS THROUGH
SECTION VIEWS

STANDARD:
BACK WINDOW REMOTE

OPTIONAL:
TOP MOUNTED
CONDENSING UNIT

STANDARD:
PASS THROUGH
REMOTE

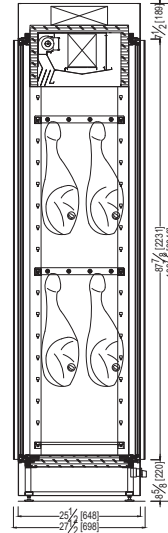
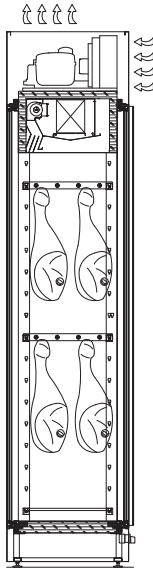
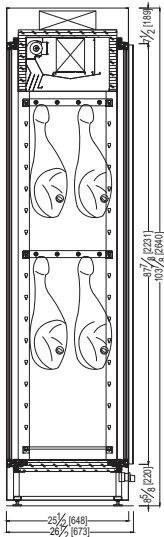

*Oscartek® reserves the right to change, modify, discontinue, or change any features, sizes, or capacity on any model without prior notice.

OSCARTEK®
512 South Airport Blvd., South San Francisco, CA 94080
Tel: 855.885.2400 | 650.342.2400 | Fax: 650.342.7400
sales@oscartek.com | www.oscartek.com





Discover the Art of Display...

Project Name: _____

Item #: _____ Quantity: _____

MODELS: GALA RM700, RM1400, RM1400-2T, RM2100, RM2100-2T, RM2800

GALA RED MEAT - REMOTE							
TECHNICAL FEATURES		MODELS					
Model Name (Model ETL Code)		GALA RM700 (MUROGALA1P)	GALA RM1400 (MUROGALA2P)	GALA RM1400-2T (MUROGALA3P) X2	GALA RM2100 (MUROGALA3P)	GALA RM2100-2T (MUROGALA2P) (MUROGALA1P)	GALA RM2800 (MUROGALA4P)
External Dimensions (L-D-H) Inches-MM	Inches MM	*30 1/4" - 30 1/8" - 90 1/2" *780 - 765 - 2300	*58 1/4" - 30 1/8" - 90 1/2" *1480 - 765 - 2300	*58 1/4" - 30 1/8" - 90 1/2" *1480 - 765 - 2300	*85 7/8" - 30 1/8" - 90 1/2" *2180 - 765 - 2300	*85 7/8" - 30 1/8" - 90 1/2" *2180 - 765 - 2300	*113 3/8" - 30 1/8" - 90 1/2" *2880 - 765 - 2300
Crated Dimensions (L-D-H) Inches-MM	Inches MM	38" - 37" - 102" 960 - 920 - 2570	66" - 37" - 102" 1660 - 920 - 2570	66" - 37" - 102" 1660 - 920 - 2570	93" - 37" - 102" 2360 - 920 - 2570	93" - 37" - 102" 2360 - 920 - 2570	121" - 37" - 102" 3060 - 920 - 2570
Refrigeration	Type	Fan - Ventilated	Fan - Ventilated	Fan - Ventilated	Fan - Ventilated	Fan - Ventilated	Fan - Ventilated
Refrigeration Display Area	Type	Deck	Deck	Deck	Deck	Deck	Deck
Number of Glass Doors	#	1	2	2	3	3	4
Operating Temperature	°F	32°F to 41°F	32°F to 41°F	32°F to 41°F	32°F to 41°F	32°F to 41°F	32°F to 41°F
Condensing Units	#	1	2	2	3	4	5
Compressor	Nr./Type	1 / Hermetic	1 / Hermetic	1 / Hermetic	1 / Hermetic	2 / Hermetic	3 / Hermetic
BTU'S @ +14°F Evap Temperature	BTU/H	2870	5260	(2) 2750	7160	2750 5150	8400
Electric Supply	(V/Ph/Hz)	220/1/60	220/1/60	(2) 220/1/60	220/1/60	(2) 220/1/60	220/1/60
Power Consumption	(W/A)	620/3.5	1200/6.5	(2) 580/3.1	1800/9.6	580/3.1 1150/6.0	2300/12.5
Defrost	Mode/Type	Automatic	Automatic	Automatic	Automatic	Automatic	Automatic
Climatic Class	°F/%RH	75°F-55%RH	75°F-55%RH	75°F-55%RH	75°F-55%RH	75°F-55%RH	75°F-55%RH
Refrigerant Gas (remote/self-contained)	Type	R452a	R452a	R452a	R452a	R452a	R452a
Pipe Size (Suction-Liquid)	(INCHES)	15/32"- 15/64"	35/64" - 5/16"	(2) 15/32"- 15/64"	5/8" - 5/16"	15/32"- 15/64" 35/64" - 5/16"	45/64" - 25/64"
Net Weights	Lb	353	617	705	816	882	970
Crated Weights	Lb	403	677	765	876	942	1030

*DIMENSIONS WITH POLISHED S/S SIDES

GALA RED MEAT - SELF CONTAINED							
TECHNICAL FEATURES		MODELS					
Model Name (Model ETL Code)		GALA RM700 (MUROGALA1P)	GALA RM1400 (MUROGALA2P)	GALA RM1400-2T (MUROGALA3P) X2	GALA RM2100 (MUROGALA3P)	GALA RM2100-2T (MUROGALA2P) (MUROGALA1P)	GALA RM2800 (MUROGALA4P)
External Dimensions (L-D-H) Inches-MM	Inches MM	*30 3/4" - 32 1/8" - 90 1/2" *780 - 815 - 2300	*58 1/4" - 32 1/8" - 90 1/2" *1480 - 815 - 2300	*58 1/4" - 32 1/8" - 90 1/2" *1480 - 815 - 2300	*85 7/8" - 32 1/8" - 90 1/2" *2180 - 815 - 2300	*85 7/8" - 32 1/8" - 90 1/2" *2180 - 815 - 2300	*113 3/8" - 32 1/8" - 90 1/2" *2880 - 815 - 2300
Crated Dimensions (L-D-H) Inches-MM	Inches MM	38" - 37" - 102" 960 - 920 - 2570	66" - 37" - 102" 1660 - 920 - 2570	66" - 37" - 102" 1660 - 920 - 2570	93" - 37" - 102" 2360 - 920 - 2570	93" - 37" - 102" 2360 - 920 - 2570	121" - 37" - 102" 3060 - 920 - 2570
Refrigeration	Type	Fan - Ventilated	Fan - Ventilated	Fan - Ventilated	Fan - Ventilated	Fan - Ventilated	Fan - Ventilated
Refrigeration Display Area	Type	Deck	Deck	Deck	Deck	Deck	Deck
Number of Glass Doors	#	1	2	2	3	3	4
Operating Temperature	°F	32°F to 41°F	32°F to 41°F	32°F to 41°F	32°F to 41°F	32°F to 41°F	32°F to 41°F
Condensing Units	#	1	2	2	3	4	5
Compressor	Nr./Type	1 / Hermetic	1 / Hermetic	1 / Hermetic	1 / Hermetic	2 / Hermetic	3 / Hermetic
BTU'S @ +14°F Evap Temperature	BTU/H	2870	5260	(2) 2750	7160	2750 5150	8400
Electric Supply	(V/Ph/Hz)	220/1/60	220/1/60	(2) 220/1/60	220/1/60	(2) 220/1/60	220/1/60
Power Consumption	(W/A)	620/3.5	1200/6.5	(2) 580/3.1	1800/9.6	580/3.1 1150/6.0	2300/12.5
Defrost	Mode/Type	Automatic	Automatic	Automatic	Automatic	Automatic	Automatic
Climatic Class	°F/%RH	75°F-55%RH	75°F-55%RH	75°F-55%RH	75°F-55%RH	75°F-55%RH	75°F-55%RH
Refrigerant Gas	Type	R290	R290	R290	R290	R290	R290
Pipe Size (Suction-Liquid)	(INCHES)	15/32"- 15/64"	35/64" - 5/16"	(2) 15/32"- 15/64"	5/8" - 5/16"	15/32"- 15/64" 35/64" - 5/16"	45/64" - 25/64"
Net Weights	Lb	353	617	705	816	882	970
Crated Weights	Lb	403	677	765	876	942	1030

*DIMENSIONS WITH POLISHED S/S SIDES

*Oscartek® reserves the right to change, modify, discontinue, or change any features, sizes, or capacity on any model without prior notice.

OSCARTEK®
512 South Airport Blvd., South San Francisco, CA 94080
Tel: 855.885.2400 | 650.342.2400 | Fax: 650.342.7400
sales@oscartek.com | www.oscartek.com





Discover the Art of Display...

Project Name: _____

Item #: _____ Quantity: _____

BACK WINDOW MODELS: GALA RM770BW, RM1370BW, RM1970BW

GALA RED MEAT BACK WINDOW - REMOTE				
TECHNICAL FEATURES		MODELS		
Model Name (Model ETL Code)		GALA BW RM770 (MUROGALA1P)	GALA BW RM1370 (MUROGALA2P)	GALA BW RM1970 (MUROGALA3P)
External Dimensions (L-D-H)	Inches	*30 1/4" - 26 1/2" - 103 7/8"	*53 7/8" - 26 1/2" - 103 7/8"	*77 1/2" - 26 1/2" - 103 7/8"
	MM	*768 - 673 - 2640	*1368 - 673 - 2640	*1968 - 673 - 2640
Crated Dimensions (L-D-H)	Inches	38" - 33" - 115"	61" - 33" - 115"	85" - 33" - 115"
	MM	948 - 828 - 2910	1548 - 828 - 2910	2148 - 828 - 2910
Refrigeration	Type	Fan - Ventilated	Fan - Ventilated	Fan - Ventilated
Refrigeration Display Area	Type	Deck	Deck	Deck
Number of Glass Doors	#	1	2	3
Operating Temperature	°F	32°F to 41°F	32°F to 41°F	32°F to 41°F
Condensing Units	#	1	2	3
Compressor	Nr./Type	1 / Hermetic	1 / Hermetic	1 / Hermetic
BTU'S @ +14°F Evap Temperature	BTU/H	3400	5300	7680
Electric Supply	(V/Ph/Hz)	220/1/60	220/1/60	220/1/60
Power Consumption	(W/A)	1600/8.2	1800/9.8	2200/11.8
Defrost	Mode/Type	Automatic	Automatic	Automatic
Climatic Class	°F/%RH	75°F-55%RH	75°F-55%RH	75°F-55%RH
Refrigerant Gas	Type	R452a	R452a	R452a
Pipe Size (Suction-Liquid)	(INCHES)	15/32" - 15/64"	35/64" - 5/16"	5/8" - 5/16"
Net Weights	Lb	551	794	970
Crated Weights	Lb	611	854	1030

*DIMENSIONS WITH POLISHED S/S SIDES

GALA RED MEAT BACK WINDOW - SELF CONTAINED				
TECHNICAL FEATURES		MODELS		
Model Name (Model ETL Code)		GALA BW RM770 (MUROGALA1P)	GALA BW RM1370 (MUROGALA2P)	GALA BW RM1970 (MUROGALA3P)
External Dimensions (L-D-H)	Inches	*30 1/4" - 26 1/2" - 111 3/4"	*53 7/8" - 26 1/2" - 111 3/4"	*77 1/2" - 26 1/2" - 111 3/4"
	MM	*768 - 673 - 2840	*1368 - 673 - 2840	*1968 - 673 - 2840
Crated Dimensions (L-D-H)	Inches	38" - 33" - 115"	61" - 33" - 115"	85" - 33" - 115"
	MM	948 - 828 - 2910	1548 - 828 - 2910	2148 - 828 - 2910
Refrigeration	Type	Fan - Ventilated	Fan - Ventilated	Fan - Ventilated
Refrigeration Display Area	Type	Deck	Deck	Deck
Number of Glass Doors	#	1	2	3
Operating Temperature	°F	32°F to 41°F	32°F to 41°F	32°F to 41°F
Condensing Units	#	1	2	3
Compressor	Nr./Type	1 / Hermetic	1 / Hermetic	1 / Hermetic
BTU'S @ +14°F Evap Temperature	BTU/H	3400	5300	7680
Electric Supply	(V/Ph/Hz)	220/1/60	220/1/60	220/1/60
Power Consumption	(W/A)	1600/8.2	1800/9.8	2200/11.8
Defrost	Mode/Type	Automatic	Automatic	Automatic
Climatic Class	°F/%RH	75°F-55%RH	75°F-55%RH	75°F-55%RH
Refrigerant Gas	Type	R455/R454c	R455/R454c	R455/R454c
Pipe Size (Suction-Liquid)	(INCHES)	15/32" - 15/64"	35/64" - 5/16"	5/8" - 5/16"
Net Weights	Lb	551	794	970
Crated Weights	Lb	611	854	1030

*DIMENSIONS WITH POLISHED S/S SIDES

*Oscartek® reserves the right to change, modify, discontinue, or change any features, sizes, or capacity on any model without prior notice.

OSCARTEK®

512 South Airport Blvd., South San Francisco, CA 94080

Tel: 855.885.2400 | 650.342.2400 | Fax: 650.342.7400

sales@oscartek.com | www.oscartek.com





Discover the Art of Display...

Project Name: _____

Item #: _____ Quantity: _____

PASS THROUGH MODELS: GALA RM770PT, RM1370PT, RM1970PT

GALA RED MEAT PASS THROUGH - REMOTE				
TECHNICAL FEATURES		MODELS		
Model Name (Model ETL Code)		GALA PT RM770 (MUROGALA1P)	GALA PT RM1370 (MUROGALA2P)	GALA PT RM1970 (MUROGALA3P)
External Dimensions (L-D-H)	Inches	*30 1/4" - 26 1/2" - 103 7/8"	*53 7/8" - 26 1/2" - 103 7/8"	*77 1/2" - 26 1/2" - 103 7/8"
Inches-MM	MM	*768 - 673 - 2640	*1368 - 673 - 2640	*1968 - 673 - 2640
Crated Dimensions (L-D-H)	Inches	38" - 33" - 115"	61" - 33" - 115"	85" - 33" - 115"
Inches-MM	MM	948 - 828 - 2910	1548 - 828 - 2910	2148 - 828 - 2910
Refrigeration	Type	Fan - Ventilated	Fan - Ventilated	Fan - Ventilated
Refrigeration Display Area	Type	Deck	Deck	Deck
Number of Glass Doors	#	1	2	3
Operating Temperature	°F	32°F to 41°F	32°F to 41°F	32°F to 41°F
Condensing Units	#	1	2	3
Compressor	Nr./Type	1 / Hermetic	1 / Hermetic	1 / Hermetic
BTU'S @ +14°F Evap Temperature	BTU/H	3400	5300	7680
Electric Supply	(V/Ph/Hz)	220/1/60	220/1/60	220/1/60
Power Consumption	(W/A)	1600/8.2	1800/9.8	2200/11.8
Defrost	Mode/Type	Automatic	Automatic	Automatic
Climatic Class	°F/%RH	75°F-55%RH	75°F-55%RH	75°F-55%RH
Refrigerant Gas	Type	R452a	R452a	R452a
Pipe Size (Suction-Liquid)	(INCHES)	15/32"- 15/64"	35/64" - 5/16"	5/8" - 5/16"
Net Weights	Lb	573	838	1036
Crated Weights	Lb	633	898	1096

*DIMENSIONS WITH POLISHED S/S SIDES

GALA RED MEAT PASS THROUGH - SELF CONTAINED				
TECHNICAL FEATURES		MODELS		
Model Name (Model ETL Code)		GALA PT RM770 (MUROGALA1P)	GALA PT RM1370 (MUROGALA2P)	GALA PT RM1970 (MUROGALA3P)
External Dimensions (L-D-H)	Inches	*30 1/4" - 26 1/2" - 111 3/4"	*53 7/8" - 26 1/2" - 111 3/4"	*77 1/2" - 26 1/2" - 111 3/4"
Inches-MM	MM	*768 - 673 - 2840	*1368 - 673 - 2840	*1968 - 673 - 2840
Crated Dimensions (L-D-H)	Inches	38" - 33" - 115"	61" - 33" - 115"	85" - 33" - 115"
Inches-MM	MM	948 - 828 - 2910	1548 - 828 - 2910	2148 - 828 - 2910
Refrigeration	Type	Fan - Ventilated	Fan - Ventilated	Fan - Ventilated
Refrigeration Display Area	Type	Deck	Deck	Deck
Number of Glass Doors	#	1	2	3
Operating Temperature	°F	32°F to 41°F	32°F to 41°F	32°F to 41°F
Condensing Units	#	1	2	3
Compressor	Nr./Type	1 / Hermetic	1 / Hermetic	1 / Hermetic
BTU'S @ +14°F Evap Temperature	BTU/H	3400	5300	7680
Electric Supply	(V/Ph/Hz)	220/1/60	220/1/60	220/1/60
Power Consumption	(W/A)	1600/8.2	1800/9.8	2200/11.8
Defrost	Mode/Type	Automatic	Automatic	Automatic
Climatic Class	°F/%RH	75°F-55%RH	75°F-55%RH	75°F-55%RH
Refrigerant Gas	Type	R455/R454c	R455/R454c	R455/R454c
Pipe Size (Suction-Liquid)	(INCHES)	15/32"- 15/64"	35/64" - 5/16"	5/8" - 5/16"
Net Weights	Lb	573	838	1036
Crated Weights	Lb	633	898	1096

*DIMENSIONS WITH POLISHED S/S SIDES

*Oscartek® reserves the right to change, modify, discontinue, or change any features, sizes, or capacity on any model without prior notice.

OSCARTEK®
512 South Airport Blvd., South San Francisco, CA 94080
Tel: 855.885.2400 | 650.342.2400 | Fax: 650.342.7400
sales@oscartek.com | www.oscartek.com





Gala Wine with black HPL exterior

Visit our website for optional RAL colors and Materials finishes.

[RAL Colors Website](#)

[Materials Brochure PDF](#)

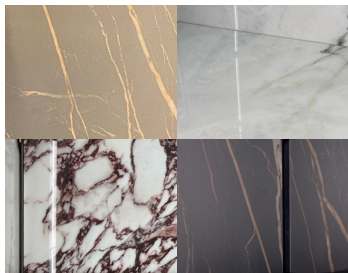

Examples of optional 6mm thick stone back panel behind shelf. For full selection see our Materials Brochure.

GALA WINE

MODELS: GALA W700, W1400, W1400-2T, W2100, W2100-2T, W2800

BACK WINDOW MODELS: GALA W770BW, W1370BW, W1970BW

PASS THROUGH MODELS: GALA W770PT, W1370PT, W1970PT

STANDARD FEATURES

- Solid Side
- Dual Medium Temperature Version with intermediate double glass divider
- Triple pane glass premium door
- Steel load bearing structure
- 3000°K LED lighting with dimmer switch
- Touch Control
- Ventilated cooling
- interior vertical shelf support in stainless steel
- adjustable feet
- standard steel 304A
- stainless steel interior and exterior
- Stainless steel shelves adjustable in height on racks
- programmed automatic electric defrost
- Approvals: cETLus, ETL sanitation, certified CE
- Remote condensing unit
- Condensate evaporator pan
- **Back Window & Pass Through:** glass shelving glass sides
- **Back Window:** rear glass side
- **Pass Through:** rear glass door

OPTIONS

- RAL Color Option powder coated door handles exterior and interior over stainless
- Front wood laminate door and handles
- interior shelf trim
- 6mm thick stone back panel behind shelf
- Glass Sides
- Wooden exterior
- top door and interior shelf trim
- Bottom mount condensing unit
- Top mounted condensing unit
- water cooled
- central refrigeration rack
- 60 Hz components UL
- 6mm thick stone back panel behind shelf
- Glass Sides
- Narrow Depth
- front breathing available for 1400L - 2800L models
- **Shelf options:** see section views

*Oscartek® reserves the right to change, modify, discontinue, or change any features, sizes, or capacity on any model without prior notice.



OSCARTEK®
512 South Airport Blvd., South San Francisco, CA 94080
Tel: 855.885.2400 | 650.342.2400 | Fax: 650.342.7400
sales@oscartek.com | www.oscartek.com



MODELS: GALA W700, W1400, W1400-2T, W2100, W2100-2T, W2800

BACK WINDOW MODELS: GALA W770BW, W1370BW, W1970BW

PASS THROUGH MODELS: GALA W770PT, W1370PT, W1970PT

ELECTRICAL LEGEND	
	REFRIGERATION LINES
	DRAIN
	POWER

GALA WINE
PLAN VIEWS

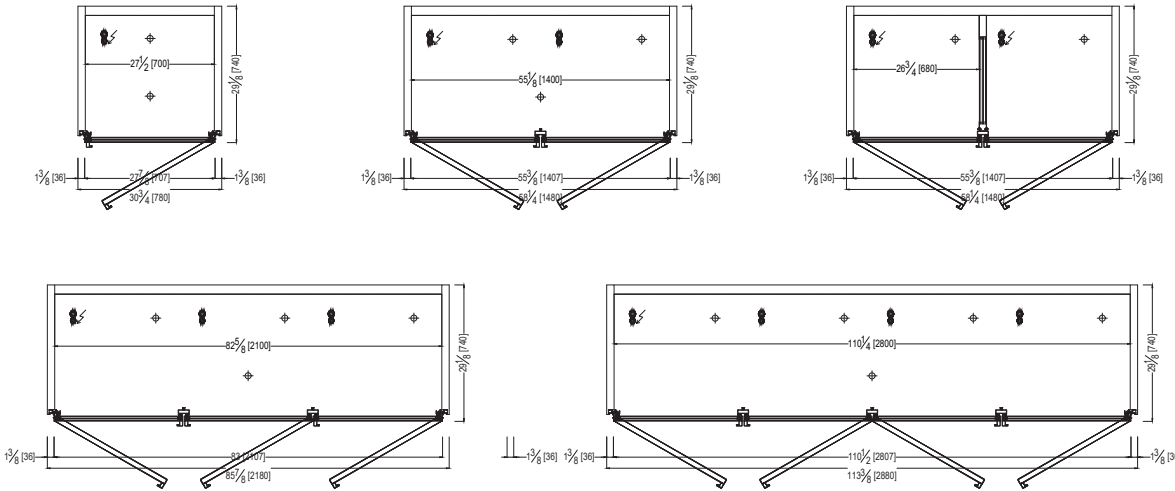

GALA WINE - BACK WINDOW
PLAN VIEWS

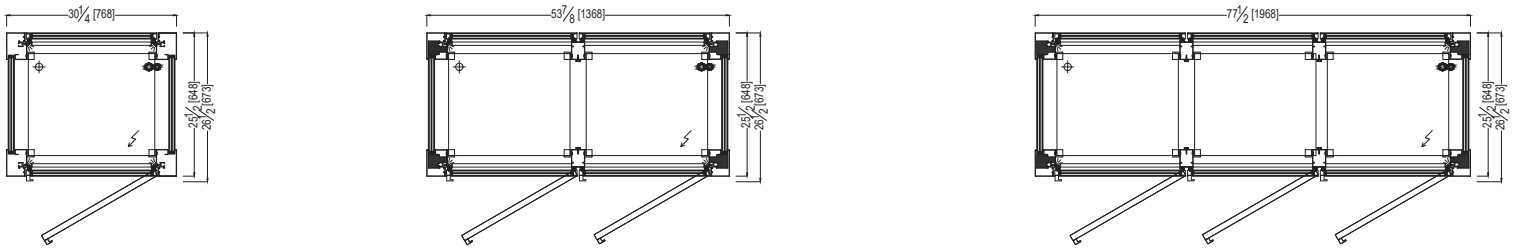

GALA WINE - PASS THROUGH
PLAN VIEWS

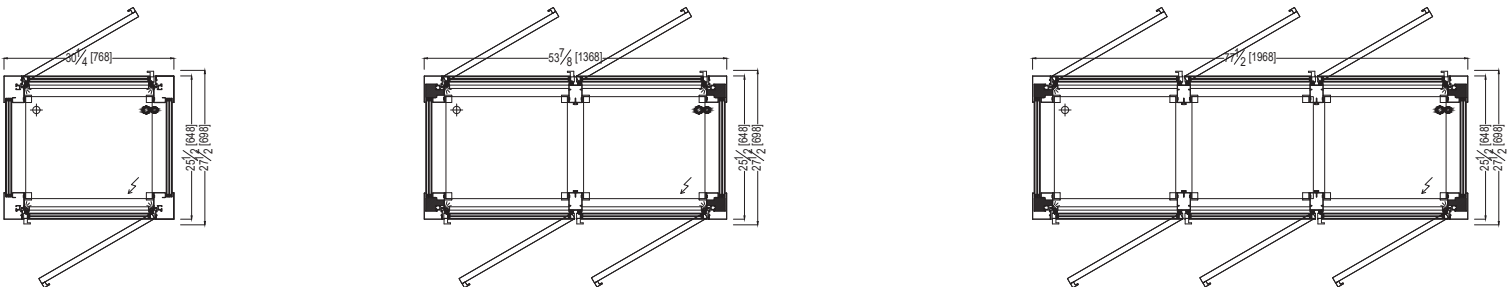

*Oscartek® reserves the right to change, modify, discontinue, or change any features, sizes, or capacity on any model without prior notice.

MODELS: GALA W700, W1400, W1400-2T, W2100, W2100-2T, W2800

BACK WINDOW MODELS: GALA W770BW, W1370BW, W1970BW

PASS THROUGH MODELS: GALA W770PT, W1370PT, W1970PT

GALA WINE
FRONT ELEVATIONS

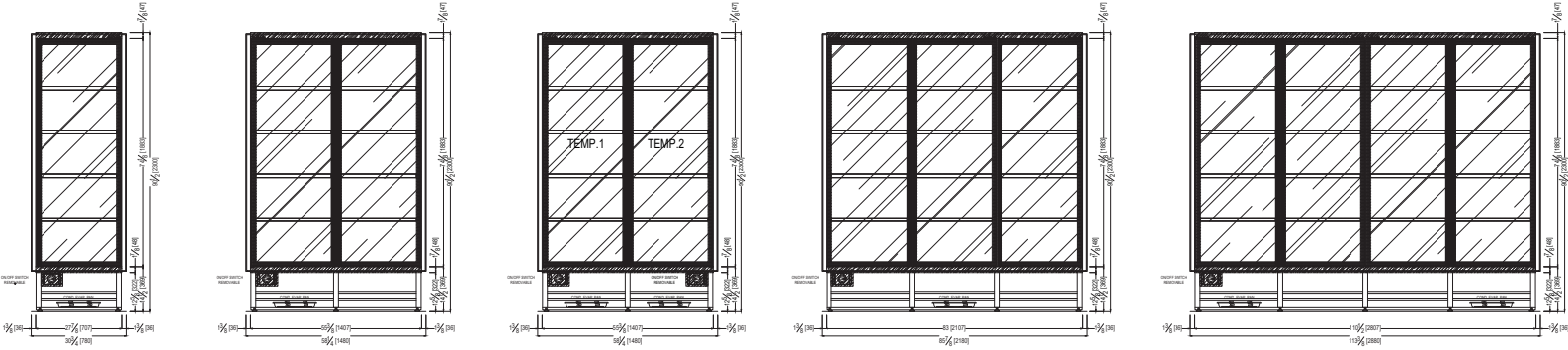

GALA WINE- BACK WINDOW & PASS THROUGH
FRONT ELEVATIONS

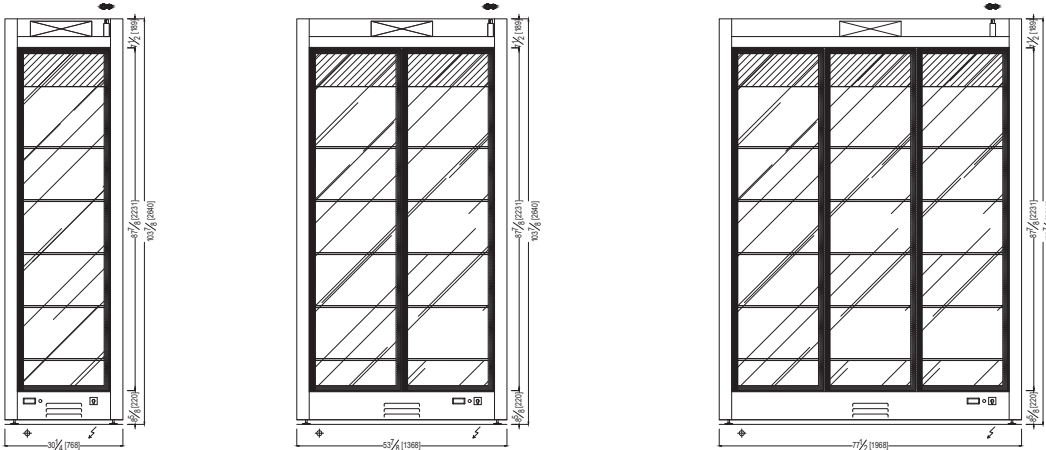

GALA WINE
WALL CUT OUT ELEVATIONS

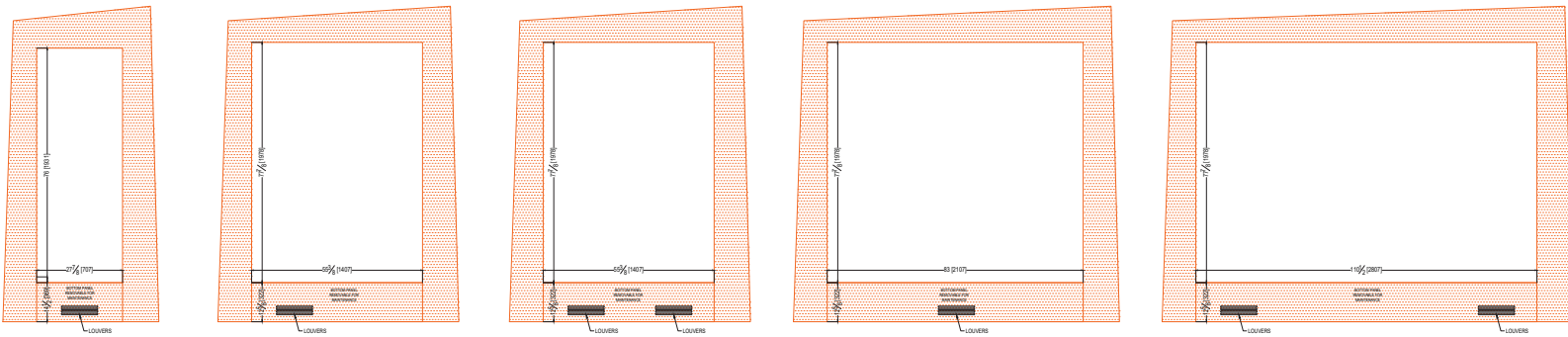

*Oscartek® reserves the right to change, modify, discontinue, or change any features, sizes, or capacity on any model without prior notice.

OSCARTEK®
512 South Airport Blvd., South San Francisco, CA 94080
Tel: 855.885.2400 | 650.342.2400 | Fax: 650.342.7400
sales@oscartek.com | www.oscartek.com



MODELS: GALA W700, W1400, W1400-2T, W2100, W2100-2T, W2800

BACK WINDOW MODELS: GALA W770BW, W1370BW, W1970BW

PASS THROUGH MODELS: GALA W770PT, W1370PT, W1970PT

GALA WINE - STANDARD DEPTH SECTION VIEWS

**STANDARD:
REMOTE**

**STANDARD:
SELF-CONTAINED
WITH
GLASS SIDE**

**OPTIONAL:
TOP MOUNTED
CONDENSING
UNIT**

**OPTIONAL:
WOODEN
EXTERIOR**

**OPTIONAL:
SLANTED
SHELVES**

**OPTIONAL:
HORIZONTAL
SHELVES**

**STANDARD:
VERTICAL
SHELVES**

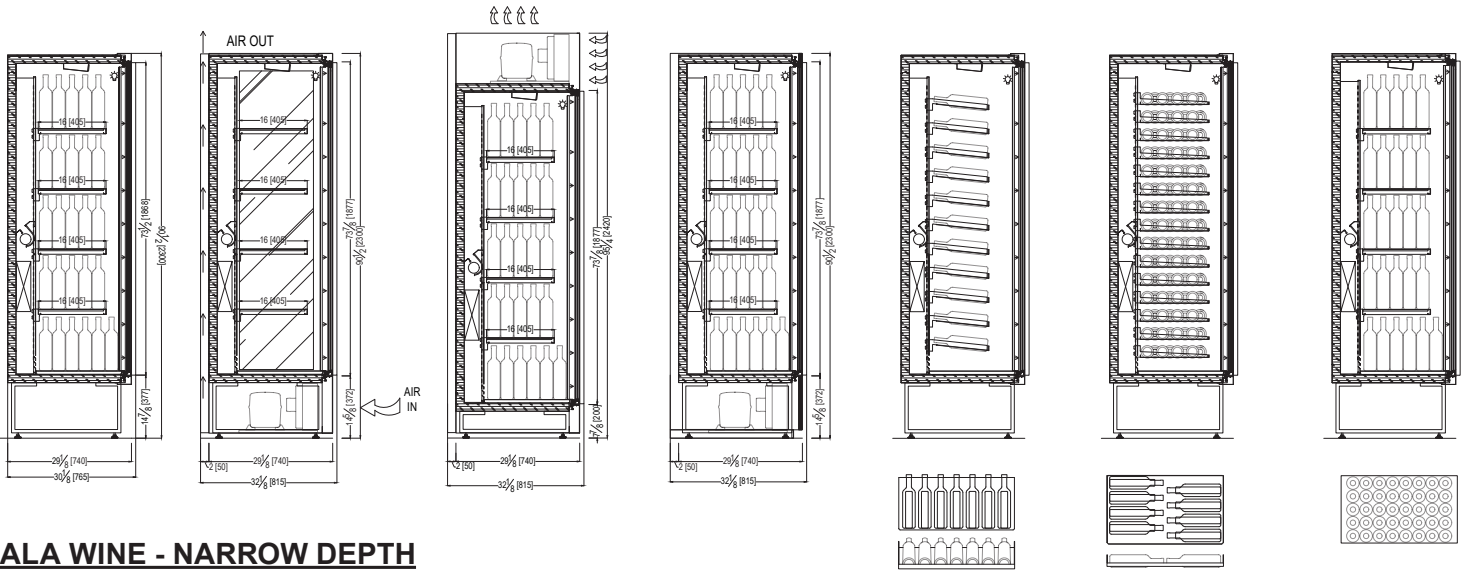

GALA WINE - NARROW DEPTH SECTION VIEWS

**STANDARD:
REMOTE**

**STANDARD:
SELF-CONTAINED**

**OPTIONAL:
TOP MOUNTED
CONDENSING
UNIT**

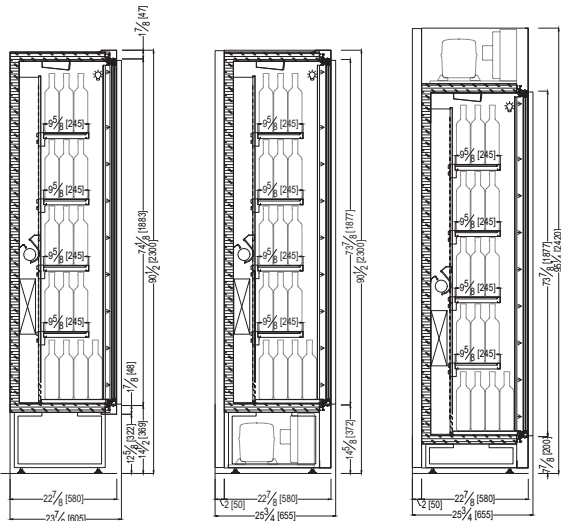

*Oscartek® reserves the right to change, modify, discontinue, or change any features, sizes, or capacity on any model without prior notice.

MODELS: GALA W700, W1400, W1400-2T, W2100, W2100-2T, W2800
BACK WINDOW MODELS: GALA W770BW, W1370BW, W1970BW
PASS THROUGH MODELS: GALA W770PT, W1370PT, W1970PT

GALA WINE BACK WINDOW & PASS THROUGH SECTION VIEWS

**STANDARD:
BACK WINDOW
REMOTE**

**OPTIONAL:
ROUND TUBULAR
PYRAMID**

**OPTIONAL:
ROUND TUBULAR
RACK**

**OPTIONAL:
SLANTED
PLEXIGLASS RACK**

**OPTIONAL:
HORIZONTAL
PLEXIGLASS RACK**

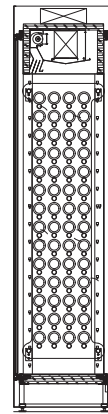
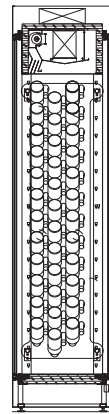
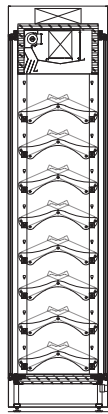
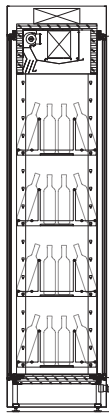
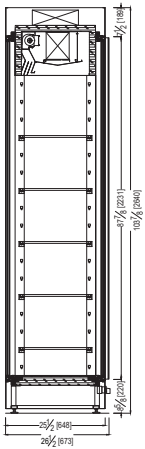

**OPTIONAL:
TOP MOUNTED
CONDENSING UNIT**

**STANDARD:
PASS THROUGH
REMOTE**

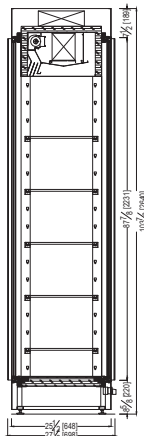
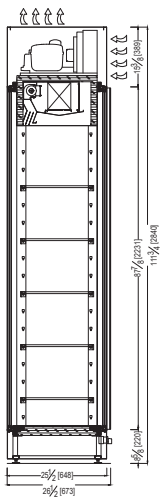

*Oscartek® reserves the right to change, modify, discontinue, or change any features, sizes, or capacity on any model without prior notice.

OSCARTEK®
 512 South Airport Blvd., South San Francisco, CA 94080
 Tel: 855.885.2400 | 650.342.2400 | Fax: 650.342.7400
 sales@oscartek.com | www.oscartek.com





Project Name: _____

Item #: _____ Quantity: _____

Discover the Art of Display...

MODELS: GALA W700, W1400, W1400-2T, W2100, W2100-2T, W2800

TECHNICAL FEATURES		GALA WINE - REMOTE					
		MODELS					
Model Name (Model ETL Code)		GALA W700 (MUROGALA1P)	GALA W1400 (MUROGALA2P)	GALA W1400-2T (MUROGALA1P) X2	GALA W2100 (MUROGALA3P)	GALA W2100-2T (MUROGALA2P) (MUROGALA1P)	GALA W2800 (MUROGALA4P)
External Dimensions (L-D-H)	Inches	*30 1/4" - 30 1/8" - 90 1/2"	*58 1/4" - 30 1/8" - 90 1/2"	*58 1/4" - 30 1/8" - 90 1/2"	*85 7/8" - 30 1/8" - 90 1/2"	*85 7/8" - 30 1/8" - 90 1/2"	*113 3/8" - 30 1/8" - 90 1/2"
Inches-MM	MM	*780 - 765 - 2300	*1480 - 765 - 2300	*1480 - 765 - 2300	*2180 - 765 - 2300	*2180 - 765 - 2300	*2880 - 765 - 2300
Crated Dimensions (L-D-H)	Inches	38" - 37" - 102"	66" - 37" - 102"	66" - 37" - 102"	93" - 37" - 102"	93" - 37" - 102"	121" - 37" - 102"
Inches-MM	MM	960 - 920 - 2570	1660 - 920 - 2570	1660 - 920 - 2570	2360 - 920 - 2570	2360 - 920 - 2570	3060 - 920 - 2570
Refrigeration	Type	Fan - Ventilated	Fan - Ventilated	Fan - Ventilated	Fan - Ventilated	Fan - Ventilated	Fan - Ventilated
Refrigeration Display Area	Type	Deck	Deck	Deck	Deck	Deck	Deck
Number of Glass Doors	#	1	2	2	3	3	4
Wine Rack Shelves	bottle orientation: #	Vertical: 5 Horizontal: 15 Slanted: 11	Vertical: 10 Horizontal: 30 Slanted: 22	Vertical: (2) 5 Horizontal: (2) 15 Slanted: (2) 11	Vertical: 15 Horizontal: 15 Slanted: 33	Vertical: 10 - 5 Horizontal: 30 - 15 Slanted: 22 - 11	Vertical: 20 Horizontal: 60 Slanted: 44
Bottle Capacity (STD size)	#	Vertical: 208 Horizontal: 120 Slanted: 77	Vertical: 416 Horizontal: 240 Slanted: 154	Vertical: (2) 208 Horizontal: (2) 120 Slanted: (2) 77	Vertical: 624 Horizontal: 360 Slanted: 231	Vertical: 416 - 208 Horizontal: 240 - 120 Slanted: 154 - 77	Vertical: 832 Horizontal: 480 Slanted: 308
Operating Temperature	*F	45°F to 58°F	45°F to 58°F	45°F to 58°F	45°F to 58°F	45°F to 58°F	45°F to 58°F
Condensing Units	#	1	2	2	3	4	5
Compressor	Nr./Type	1 / Hermetic	1 / Hermetic	1 / Hermetic	1 / Hermetic	2 / Hermetic	3 / Hermetic
BTU'S @ +14°F Evap Temperature	BTU/H	2870	5260	(2) 2750	7160	5150	8400
Electric Supply	(V/Ph/Hz)	220/1/60	220/1/60	(2) 220/1/60	220/1/60	(2) 220/1/60	220/1/60
Power Consumption	(W/A)	620/3.5	1200/6.5	(2) 580/3.1	1800/9.6	1150/6.0	2300/12.5
Defrost	Mode/Type	Automatic	Automatic	Automatic	Automatic	Automatic	Automatic
Climatic Class	*F/%RH	75°F-55%RH	75°F-55%RH	75°F-55%RH	75°F-55%RH	75°F-55%RH	75°F-55%RH
Refrigerant Gas	Type	R452a	R452a	R452a	R452a	R452a	R452a
Pipe Size (Suction-Liquid)	(INCHES)	15/32" - 15/64"	35/64" - 5/16"	(2) 15/32" - 15/64"	5/8" - 5/16"	15/32" - 15/64" 35/64" - 5/16"	45/64" - 25/64"
Net Weights	Lb	353	617	705	816	882	970
Crated Weights	Lb	403	677	765	876	942	1030

*DIMENSIONS WITH POLISHED S/S SIDES

TECHNICAL FEATURES		GALA WINE - SELF CONTAINED					
		MODELS					
Model Name (Model ETL Code)		GALA W700 (MUROGALA1P)	GALA W1400 (MUROGALA2P)	GALA W1400-2T (MUROGALA1P) X2	GALA W2100 (MUROGALA3P)	GALA W2100-2T (MUROGALA2P) (MUROGALA1P)	GALA W2800 (MUROGALA4P)
External Dimensions (L-D-H)	Inches	*30 3/4" - 32 1/8" - 90 1/2"	*58 1/4" - 32 1/8" - 90 1/2"	*58 1/4" - 32 1/8" - 90 1/2"	*85 7/8" - 32 1/8" - 90 1/2"	*85 7/8" - 32 1/8" - 90 1/2"	*113 3/8" - 32 1/8" - 90 1/2"
Inches-MM	MM	*780 - 815 - 2300	*1480 - 815 - 2300	*1480 - 815 - 2300	*2180 - 815 - 2300	*2180 - 815 - 2300	*2880 - 815 - 2300
Crated Dimensions (L-D-H)	Inches	38" - 37" - 102"	66" - 37" - 102"	66" - 37" - 102"	93" - 37" - 102"	93" - 37" - 102"	121" - 37" - 102"
Inches-MM	MM	960 - 920 - 2570	1660 - 920 - 2570	1660 - 920 - 2570	2360 - 920 - 2570	2360 - 920 - 2570	3060 - 920 - 2570
Refrigeration	Type	Fan - Ventilated	Fan - Ventilated	Fan - Ventilated	Fan - Ventilated	Fan - Ventilated	Fan - Ventilated
Refrigeration Display Area	Type	Deck	Deck	Deck	Deck	Deck	Deck
Number of Glass Doors	#	1	2	2	3	3	4
Wine Rack Shelves	bottle orientation: #	Vertical: 5 Horizontal: 15 Slanted: 11	Vertical: 10 Horizontal: 30 Slanted: 22	Vertical: (2) 5 Horizontal: (2) 15 Slanted: (2) 11	Vertical: 15 Horizontal: 15 Slanted: 33	Vertical: 10 - 5 Horizontal: 30 - 15 Slanted: 22 - 11	Vertical: 20 Horizontal: 60 Slanted: 44
Bottle Capacity (STD size)	#	Vertical: 208 Horizontal: 120 Slanted: 77	Vertical: 416 Horizontal: 240 Slanted: 154	Vertical: (2) 208 Horizontal: (2) 120 Slanted: (2) 77	Vertical: 624 Horizontal: 360 Slanted: 231	Vertical: 416 - 208 Horizontal: 240 - 120 Slanted: 154 - 77	Vertical: 832 Horizontal: 480 Slanted: 308
Operating Temperature	*F	45°F to 58°F	45°F to 58°F	45°F to 58°F	45°F to 58°F	45°F to 58°F	45°F to 58°F
Condensing Units	#	1	2	2	3	4	5
Compressor	Nr./Type	1 / Hermetic	1 / Hermetic	1 / Hermetic	1 / Hermetic	2 / Hermetic	3 / Hermetic
BTU'S @ +14°F Evap Temperature	BTU/H	2870	5260	(2) 2750	7160	5150	8400
Electric Supply	(V/Ph/Hz)	220/1/60	220/1/60	(2) 220/1/60	220/1/60	(2) 220/1/60	220/1/60
Power Consumption	(W/A)	620/3.5	1200/6.5	(2) 580/3.1	1800/9.6	1150/6.0	2300/12.5
Defrost	Mode/Type	Automatic	Automatic	Automatic	Automatic	Automatic	Automatic
Climatic Class	*F/%RH	75°F-55%RH	75°F-55%RH	75°F-55%RH	75°F-55%RH	75°F-55%RH	75°F-55%RH
Refrigerant Gas	Type	R290	R290	R290	R290	R290	R290
Pipe Size (Suction-Liquid)	(INCHES)	15/32" - 15/64"	35/64" - 5/16"	(2) 15/32" - 15/64"	5/8" - 5/16"	15/32" - 15/64" 35/64" - 5/16"	45/64" - 25/64"
Net Weights	Lb	353	617	705	816	882	970
Crated Weights	Lb	403	677	765	876	942	1030

*DIMENSIONS WITH POLISHED S/S SIDES

*Oscartek® reserves the right to change, modify, discontinue, or change any features, sizes, or capacity on any model without prior notice.

OSCARTEK®
512 South Airport Blvd., South San Francisco, CA 94080
Tel: 855.885.2400 | 650.342.2400 | Fax: 650.342.7400
sales@oscartek.com | www.oscartek.com





Discover the Art of Display...

Project Name: _____

Item #: _____ Quantity: _____

BACK WINDOW MODELS: GALA W770BW, W1370BW, W1970BW

GALA WINE BACK WINDOW - REMOTE				
TECHNICAL FEATURES		MODELS		
Model Name (Model ETL Code)		GALA BW W770 (MUROGALA1P)	GALA BW W1370 (MUROGALA2P)	GALA BW W1970 (MUROGALA3P)
External Dimensions (L-D-H) Inches-MM	Inches MM	*30 1/4" - 26 1/2" - 103 7/8" *768 - 673 - 2640	*53 7/8" - 26 1/2" - 103 7/8" *1368 - 673 - 2640	*77 1/2" - 26 1/2" - 103 7/8" *1968 - 673 - 2640
Crated Dimensions (L-D-H) Inches-MM	Inches MM	38" - 33" - 115" 948 - 828 - 2910	61" - 33" - 115" 1548 - 828 - 2910	85" - 33" - 115" 2148 - 828 - 2910
Refrigeration	Type	Fan - Ventilated	Fan - Ventilated	Fan - Ventilated
Refrigeration Display Area	Type	Deck	Deck	Deck
Number of Glass Doors	#	1	2	3
Wine Rack Shelves	bottle orientation: #	Vertical: 5 Round tubular pyramid: 4 Round tubular Rack: 8 Slanted Plexiglass Rack: 2 Horizontal Plexiglass Rack: 2	Vertical: 10 Round tubular pyramid: 8 Round tubular Rack: 16 Slanted Plexiglass Rack: 4 Horizontal Plexiglass Rack: 4	Vertical: 15 Round tubular pyramid: 12 Round tubular Rack: 24 Slanted Plexiglass Rack: 6 Horizontal Plexiglass Rack: 6
Bottle Capacity (STD size)	#	Vertical: 100 Round tubular pyramid: 104 Round tubular Rack: 72 Slanted Plexiglass Rack: 72 Horizontal Plexiglass Rack: 112	Vertical: 200 Round tubular pyramid: 208 Round tubular Rack: 144 Slanted Plexiglass Rack: 144 Horizontal Plexiglass Rack: 224	Vertical: 300 Round tubular pyramid: 312 Round tubular Rack: 216 Slanted Plexiglass Rack: 216 Horizontal Plexiglass Rack: 336
Operating Temperature	°F	45°F to 58°F	45°F to 58°F	45°F to 58°F
Condensing Units	#	1	2	3
Compressor	Nr./Type	1 / Hermetic	1 / Hermetic	1 / Hermetic
BTU'S @ +14°F Evap Temperature	BTU/H	3400	5300	7680
Electric Supply	(V/Ph/Hz)	220/1/60	220/1/60	220/1/60
Power Consumption	(W/A)	1600/8.2	1800/9.8	2200/11.8
Defrost	Mode/Type	Automatic	Automatic	Automatic
Climatic Class	°F/%RH	75°F-55%RH	75°F-55%RH	75°F-55%RH
Refrigerant Gas	Type	R452a	R452a	R452a
Pipe Size (Suction-Liquid)	(INCHES)	15/32" - 15/64"	35/64" - 5/16"	5/8" - 5/16"
Net Weights	Lb	551	794	970
Crated Weights	Lb	611	854	1030

*DIMENSIONS WITH POLISHED S/S SIDES

GALA WINE BACK WINDOW - SELF CONTAINED				
TECHNICAL FEATURES		MODELS		
Model Name (Model ETL Code)		GALA BW W770 (MUROGALA1P)	GALA BW W1370 (MUROGALA2P)	GALA BW W1970 (MUROGALA3P)
External Dimensions (L-D-H) Inches-MM	Inches MM	*30 1/4" - 26 1/2" - 111 3/4" *768 - 673 - 2840	*53 7/8" - 26 1/2" - 111 3/4" *1368 - 673 - 2840	*77 1/2" - 26 1/2" - 111 3/4" *1968 - 673 - 2840
Crated Dimensions (L-D-H) Inches-MM	Inches MM	38" - 33" - 115" 948 - 828 - 2910	61" - 33" - 115" 1548 - 828 - 2910	85" - 33" - 115" 2148 - 828 - 2910
Refrigeration	Type	Fan - Ventilated	Fan - Ventilated	Fan - Ventilated
Refrigeration Display Area	Type	Deck	Deck	Deck
Number of Glass Doors	#	1	2	3
Wine Rack Shelves	bottle orientation: #	Vertical: 5 Round tubular pyramid: 4 Round tubular Rack: 8 Slanted Plexiglass Rack: 2 Horizontal Plexiglass Rack: 2	Vertical: 10 Round tubular pyramid: 8 Round tubular Rack: 16 Slanted Plexiglass Rack: 4 Horizontal Plexiglass Rack: 4	Vertical: 15 Round tubular pyramid: 12 Round tubular Rack: 24 Slanted Plexiglass Rack: 6 Horizontal Plexiglass Rack: 6
Bottle Capacity (STD size)	#	Vertical: 100 Round tubular pyramid: 104 Round tubular Rack: 72 Slanted Plexiglass Rack: 72 Horizontal Plexiglass Rack: 112	Vertical: 200 Round tubular pyramid: 208 Round tubular Rack: 144 Slanted Plexiglass Rack: 144 Horizontal Plexiglass Rack: 224	Vertical: 300 Round tubular pyramid: 312 Round tubular Rack: 216 Slanted Plexiglass Rack: 216 Horizontal Plexiglass Rack: 336
Operating Temperature	°F	45°F to 58°F	45°F to 58°F	45°F to 58°F
Condensing Units	#	1	2	3
Compressor	Nr./Type	1 / Hermetic	1 / Hermetic	1 / Hermetic
BTU'S @ +14°F Evap Temperature	BTU/H	3400	5300	7680
Electric Supply	(V/Ph/Hz)	220/1/60	220/1/60	220/1/60
Power Consumption	(W/A)	1600/8.2	1800/9.8	2200/11.8
Defrost	Mode/Type	Automatic	Automatic	Automatic
Climatic Class	°F/%RH	75°F-55%RH	75°F-55%RH	75°F-55%RH
Refrigerant Gas	Type	R455/R454c	R455/R454c	R455/R454c
Pipe Size (Suction-Liquid)	(INCHES)	15/32" - 15/64"	35/64" - 5/16"	5/8" - 5/16"
Net Weights	Lb	551	794	970
Crated Weights	Lb	611	854	1030

*DIMENSIONS WITH POLISHED S/S SIDES

*Oscartek® reserves the right to change, modify, discontinue, or change any features, sizes, or capacity on any model without prior notice.

OSCARTEK®
512 South Airport Blvd., South San Francisco, CA 94080
Tel: 855.885.2400 | 650.342.2400 | Fax: 650.342.7400
sales@oscartek.com | www.oscartek.com





Discover the Art of Display...

Project Name: _____

Item #: _____ Quantity: _____

PASS THROUGH MODELS: GALA W770PT, W1370PT, W1970PT

GALA WINE PASS THROUGH - REMOTE				
TECHNICAL FEATURES		MODELS		
Model Name (Model ETL Code)		GALA PT W770 (MUROGALA1P)	GALA PT W1370 (MUROGALA2P)	GALA PT W1970 (MUROGALA3P)
External Dimensions (L-D-H) Inches-MM	Inches MM	*30 1/4" - 26 1/2" - 103 7/8" *768 - 673 - 2640	*53 7/8" - 26 1/2" - 103 7/8" *1368 - 673 - 2640	*77 1/2" - 26 1/2" - 103 7/8" *1968 - 673 - 2640
Crated Dimensions (L-D-H) Inches-MM	Inches MM	38" - 33" - 115" 948 - 828 - 2910	61" - 33" - 115" 1548 - 828 - 2910	85" - 33" - 115" 2148 - 828 - 2910
Refrigeration	Type	Fan - Ventilated	Fan - Ventilated	Fan - Ventilated
Refrigeration Display Area	Type	Deck	Deck	Deck
Number of Glass Doors	#	1	2	3
Wine Rack Shelves	bottle orientation: #	Vertical: 5 Round tubular pyramid: 4 Round tubular Rack: 8 Slanted Plexiglass Rack: 2 Horizontal Plexiglass Rack: 2	Vertical: 10 Round tubular pyramid: 8 Round tubular Rack: 16 Slanted Plexiglass Rack: 4 Horizontal Plexiglass Rack: 4	Vertical: 15 Round tubular pyramid: 12 Round tubular Rack: 24 Slanted Plexiglass Rack: 6 Horizontal Plexiglass Rack: 6
Bottle Capacity (STD size)	bottle orientation: #	Vertical: 100 Round tubular pyramid: 104 Round tubular Rack: 72 Slanted Plexiglass Rack: 72 Horizontal Plexiglass Rack: 112	Vertical: 200 Round tubular pyramid: 208 Round tubular Rack: 144 Slanted Plexiglass Rack: 144 Horizontal Plexiglass Rack: 224	Vertical: 300 Round tubular pyramid: 312 Round tubular Rack: 216 Slanted Plexiglass Rack: 216 Horizontal Plexiglass Rack: 336
Operating Temperature	°F	45°F to 58°F	45°F to 58°F	45°F to 58°F
Condensing Units	#	1	2	3
Compressor	Nr./Type	1 / Hermetic	1 / Hermetic	1 / Hermetic
BTU'S @ +14°F Evap Temperature	BTU/H	3400	5300	7680
Electric Supply	(V/Ph/Hz)	220/1/60	220/1/60	220/1/60
Power Consumption	(W/A)	1600/8.2	1800/9.8	2200/11.8
Defrost	Mode/Type	Automatic	Automatic	Automatic
Climatic Class	°F/%RH	75°F-55%RH	75°F-55%RH	75°F-55%RH
Refrigerant Gas	Type	R452a	R452a	R452a
Pipe Size (Suction-Liquid)	(INCHES)	15/32" - 15/64"	35/64" - 5/16"	5/8" - 5/16"
Net Weights	Lb	573	838	1036
Crated Weights	Lb	633	898	1096

*DIMENSIONS WITH POLISHED S/S SIDES

GALA WINE PASS THROUGH - SELF CONTAINED				
TECHNICAL FEATURES		MODELS		
Model Name (Model ETL Code)		GALA PT W770 (MUROGALA1P)	GALA PT W1370 (MUROGALA2P)	GALA PT W1970 (MUROGALA3P)
External Dimensions (L-D-H) Inches-MM	Inches MM	*30 1/4" - 26 1/2" - 111 3/4" *768 - 673 - 2840	*53 7/8" - 26 1/2" - 111 3/4" *1368 - 673 - 2840	*77 1/2" - 26 1/2" - 111 3/4" *1968 - 673 - 2840
Crated Dimensions (L-D-H) Inches-MM	Inches MM	38" - 33" - 115" 948 - 828 - 2910	61" - 33" - 115" 1548 - 828 - 2910	85" - 33" - 115" 2148 - 828 - 2910
Refrigeration	Type	Fan - Ventilated	Fan - Ventilated	Fan - Ventilated
Refrigeration Display Area	Type	Deck	Deck	Deck
Number of Glass Doors	#	1	2	3
Wine Rack Shelves	bottle orientation: #	Vertical: 5 Round tubular pyramid: 4 Round tubular Rack: 8 Slanted Plexiglass Rack: 2 Horizontal Plexiglass Rack: 2	Vertical: 10 Round tubular pyramid: 8 Round tubular Rack: 16 Slanted Plexiglass Rack: 4 Horizontal Plexiglass Rack: 4	Vertical: 15 Round tubular pyramid: 12 Round tubular Rack: 24 Slanted Plexiglass Rack: 6 Horizontal Plexiglass Rack: 6
Bottle Capacity (STD size)	bottle orientation: #	Vertical: 100 Round tubular pyramid: 104 Round tubular Rack: 72 Slanted Plexiglass Rack: 72 Horizontal Plexiglass Rack: 112	Vertical: 200 Round tubular pyramid: 208 Round tubular Rack: 144 Slanted Plexiglass Rack: 144 Horizontal Plexiglass Rack: 224	Vertical: 300 Round tubular pyramid: 312 Round tubular Rack: 216 Slanted Plexiglass Rack: 216 Horizontal Plexiglass Rack: 336
Operating Temperature	°F	45°F to 58°F	45°F to 58°F	45°F to 58°F
Condensing Units	#	1	2	3
Compressor	Nr./Type	1 / Hermetic	1 / Hermetic	1 / Hermetic
BTU'S @ +14°F Evap Temperature	BTU/H	3400	5300	7680
Electric Supply	(V/Ph/Hz)	220/1/60	220/1/60	220/1/60
Power Consumption	(W/A)	1600/8.2	1800/9.8	2200/11.8
Defrost	Mode/Type	Automatic	Automatic	Automatic
Climatic Class	°F/%RH	75°F-55%RH	75°F-55%RH	75°F-55%RH
Refrigerant Gas	Type	R455/R454c	R455/R454c	R455/R454c
Pipe Size (Suction-Liquid)	(INCHES)	15/32" - 15/64"	35/64" - 5/16"	5/8" - 5/16"
Net Weights	Lb	573	838	1036
Crated Weights	Lb	633	898	1096

*DIMENSIONS WITH POLISHED S/S SIDES

*Oscartek® reserves the right to change, modify, discontinue, or change any features, sizes, or capacity on any model without prior notice.

OSCARTEK®
512 South Airport Blvd., South San Francisco, CA 94080
Tel: 855.885.2400 | 650.342.2400 | Fax: 650.342.7400
sales@oscartek.com | www.oscartek.com

